

EVERSE 8

EVERSE8-US, EVERSE8-EU, EVERSE8-W

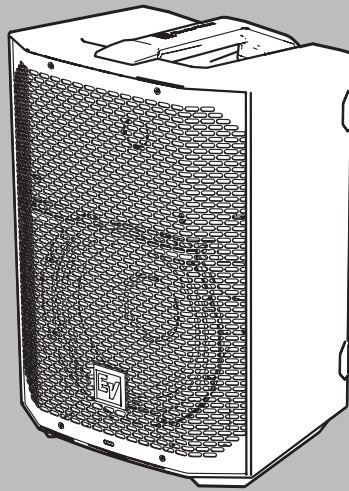





Table of contents

1	Safety	4
1.1	Important safety instructions	4
1.2	Battery and internal charger safety rules	5
1.3	Suspension	8
1.4	FCC information	8
1.5	Simplified Declaration of Conformity (sDoC)	9
1.6	Precautions	11
1.7	Certifications	11
1.8	Notices	13
2	Description	15
2.1	Short information	15
2.2	System features	16
2.3	Quick setup	16
3	Pairing the QuickSmart Mobile app	18
4	Operation	21
4.1	Installation and charging of battery pack	21
4.2	Weatherization	22
4.3	Installation of weatherized input cover	25
4.4	Tripod or pole mount	26
4.5	Floor monitor & kickback	28
5	Amplifier DSP	30
5.1	Amplifier DSP controls	30
5.2	System status	31
5.3	DSP controls	32
5.3.1	Loudspeaker DSP control menu	33
6	Input & Mixer operation	44
6.1	INPUT DSP control menu	44
7	Recommended configurations	49
7.1	Connecting with mobile device	49
7.2	Street musician performance	50
7.3	Bluetooth true wireless stereo (TWS)	51
7.4	Using as monitor	52
8	Troubleshooting	53
9	Technical data	56
9.1	Dimensions	57
9.2	Frequency response	57
10	Appendices	58
10.1	Effects (FX) list	58

1 Safety

1.1 Important safety instructions

 <p>WARNING: TO REDUCE THE RISK OF FIRE OR ELECTRIC SHOCK, DO NOT OVEREXPOSE THIS APPLIANCE TO RAIN OR MOISTURE</p> <p>AVIS: RISQUE DE CHOC ELECTRIQUE, NE PAS OUVRIR.</p> <p>WARNING: THE MAINS PLUG OR AC INLET IS USED AS A DISCONNECT DEVICE. THE DISCONNECT DEVICE SHALL REMAIN READILY OPERABLE.</p> <p>WARNING: CONNECT ONLY TO MAINS SOCKET WITH PROTECTIVE EARTHING CONNECTION.</p> <p>WARNING: TO REDUCE THE RISK OF ELECTRIC SHOCK, DO NOT REMOVE COVER (OR BACK) AS THERE ARE NO USER-SERVICABLE PARTS INSIDE. REFER SERVICING TO QUALIFIED PERSONNEL.</p>		<p>The lightning flash with arrowhead symbol, within an equilateral triangle is intended to alert the user to the presence of uninsulated “dangerous voltage” within the product’s enclosure that may be sufficient magnitude to constitute a risk of electric shock to persons.</p>
		<p>The exclamation point within an equilateral triangle is intended to alert the user to the presence of important operating and maintenance (servicing) instructions in the literature accompanying the appliance.</p>
		<p>The asterisk within an equilateral triangle is intended to inform the user to necessary installation or removal instructions regarding equipment or hardware use relating to the system.</p>

1. Read these instructions.
2. Keep these instructions.
3. Heed all warnings.
4. Follow all instructions.
5. Do not use this apparatus near water other than explicitly called out in this manual.
6. Clean only with a dry cloth.
7. Do not block any ventilation openings. Install in accordance with the manufacturer's instructions.
8. Do not install near any heat sources such as radiators, heat registers, stoves, or other apparatus (including amplifiers) that produce heat.
9. Do not defeat the safety purpose of the polarized or grounding-type plug. A polarized plug has two blades with one wider than the other. A grounding type plug has two blades and a third grounding prong. The wide blade or the third prong is provided for your safety. If the provided plug does not fit into your outlet, consult an electrician for replacement of the obsolete outlet.
10. Protect the power cord from being walked on or pinched particularly at plugs, convenience receptacles, and the point where they exit from the apparatus.
11. Only use attachments/accessories specified by the manufacturer.
12. Use only with the cart, stand, tripod, bracket, or table specified by the manufacturer, or with the apparatus. When a cart is used, use caution when moving the cart/apparatus combination to avoid injury from tip-over.
13. Unplug the apparatus during lightning storms or when unused for long periods of time.

14. Refer all servicing to qualified service personnel. Servicing is required when the apparatus has been damaged in any way, such as power-supply cord or plug is damaged, liquid has been spilled or objects have fallen into the apparatus, the apparatus has been exposed to rain or moisture, does not operate normally, or has been dropped.
 15. No naked flame sources, such as lighted candles, should be placed on the apparatus.
 16. To reduce the risk of fire or electric shock, do not expose this apparatus to rain or moisture in any other method than the ones explicitly called out in this manual. The apparatus should not be exposed to dripping or splashing without the included weather cover or accessory rain cover, as covered in this manual. Objects filled with liquids, such as vases should not be placed on apparatus.
 17. Do not block any ventilation openings. Install in accordance with the manufacturer's instructions.
 18. Minimum 60 cm (2 ft) distances around the apparatus for sufficient ventilation.
 19. The ventilation should not be impeded by covering the ventilation openings with items, such as newspapers, table-cloths, curtains, etc.
 20. To completely disconnect AC power from this apparatus, the power supply cord must be unplugged.
 21. Power cord options:
 - Mains plug**
 - Use a 3-pin mains plug that is registered with the Safety Authority.
 - Use a 2-pin mains plug that is certified¹ to EN 50075/IEC 60083 Standard C5 (shown in the Appendix S of Singapore Consumer Protection (Safety Requirements) Registration Scheme Information).
 - Flexible cord**
 - Use a double insulated flexible cord that is certified¹ to the relevant IEC standards.
 - Appliance connector**
 - Use an appliance connector certified¹ to IEC 60320.
- ¹Certified by member of IECEE CB Scheme.



Warning!

Use of non-authorized accessories or attachments with this or any Electro-Voice product is at your own discretion. Use of non-authorized accessories or attachments can result in product malfunction, injury, or death.

The user assumes all liability and may result in the warranty being voided.

1.2

Battery and internal charger safety rules

1. SAVE THESE INSTRUCTIONS. This manual contains important safety and operating instructions for Electro-Voice EVERSE loudspeaker.
2. Before using Electro-Voice EVERSE internal battery charger to re-charge the battery, read all instructions and warning markings on (1) battery, (2) EVERSE loudspeaker.
3. To reduce the risk of injury, charge only Electro-Voice battery packs specified for use with the EVERSE loudspeaker. Other types of batteries may burst causing personal injury and damage.
4. Only charge the battery pack in temperatures above 0 °C (+32 °F) and below 35 °C (+95 °F). Avoid charging battery in direct sunlight. Store the loudspeaker and the battery pack in locations where temperatures will not exceed 45 °C (113 °F). This is important to prevent serious damage to the battery cells.

5. Unless otherwise specified by Electro-Voice with the use of approved accessories, do not recharge the battery in a damp or wet environment and do not expose the loudspeaker to rain or snow while plugged in to mains power. Water entering battery charger may result in electric shock or fire.

**Caution!**

Always use the supplied weather cover and/or Electro-Voice approved rain cover accessory in wet environments.

6. Never submerge the battery pack, or the EVERSE loudspeaker in fluid of any kind or allow fluid to enter them. Corrosive or conductive fluid (such as seawater or industrial chemical or bleach containing products, etc.) can cause short circuit, which may result in fire, personal injury and property damage.
7. Battery leakage may occur under extreme usage or temperature conditions. Avoid contact with skin and eyes. The battery liquid is caustic and could cause chemical burns to tissues. If liquid comes in contact with skin, wash quickly with soap and water. If the liquid contacts your eyes, flush them with water for a minimum of 10 minutes and seek medical attention.
8. Place the EVERSE loudspeaker on flat nonflammable surfaces and away from flammable materials when using or charging the battery pack. Carpeting and other heat insulating surfaces block proper air circulation which may cause overheating of the charger and battery pack. If smoke or melting of the loudspeaker or battery pack is observed, unplug the loudspeaker immediately and do not use the battery pack or the loudspeaker. Contact customer service immediately.
9. Make sure cord is located so that it will not be stepped on, tripped over, or otherwise subjected to damage or stress. Damaged plug and cord may result in electric shock or fire.
10. Disconnect the EVERSE loudspeaker by pulling the plug rather than the cord. Do not operate the EVERSE loudspeaker with damaged cord or plug. Have them replaced immediately. Damaged plug or cord may result in electric shock or fire.
11. Do not insert the battery pack in the EVERSE loudspeaker if the battery pack case is cracked or visibly damaged. Using a damaged battery pack may result in electric shock or fire.
12. Do not disassemble or operate the EVERSE loudspeaker if it has received a sharp blow, been dropped or otherwise damaged in anyway. Incorrect reassembly or damage may result in electric shock or fire.
13. Before each use, check the EVERSE loudspeaker, cable, plug and battery pack. Do not use if damage is detected. Never open the battery pack yourself, take it to an Electro-Voice Service Center, only using original replacement parts. Incorrect reassembly or using damaged product may result in electric shock or fire.
14. Only use accessories or batteries recommended or sold by Electro-Voice. Using attachments not recommended may result in electric shock or fire.
15. Unplug the EVERSE loudspeaker from outlet before storage, attempting any maintenance or cleaning. Such preventive safety measures reduce the risk of electric shock or fire.
16. Replace battery pack if a substantial drop in operating time per charge is observed. Battery pack may be nearing the end of its life.

Battery care

**Warning!**

When batteries are not installed in a loudspeaker, keep them away from metal objects. For example, to protect terminals from shorting **DO NOT** place batteries in a tool box or pocket with nails, screws, keys, etc. Fire or injury may result.

DO NOT PUT BATTERIES INTO FIRE or expose to high heat. They may explode.

**Warning!**

Do not attempt to disassemble the battery or remove any component projecting from the battery terminals. Fire or injury may result. Prior to disposal, protect exposed terminals with heavy insulating tape to prevent shorting.

**Warning!**

Do not use the EVERSE loudspeaker in damp or wet environments without the proper installation of the included weather cover or Electro-Voice approved rain cover in accordance with the user manual.

Always ensure any device, cable, or instrument connected to the EVERSE loudspeaker is also properly protected from moisture, properly grounded with ground fault circuit interrupt, and used in accordance with their respective manufacturer's directions.

**Notice!**

Electro-Voice battery packs

Use of battery packs not sold by Electro-Voice will void the warranty.

**Notice!**

Battery protection mode

The lithium-ion battery is protected against deep discharging by the "Battery protection mode". When the battery is empty, the EVERSE loudspeaker enters a battery protection mode. The battery is supplied partially charged. Completely charge the battery before using your loudspeaker for the first time. The lithium-ion battery can be charged at any time, without reducing its service life. Interrupting the charging procedure does not damage the battery.

**Notice!**

Battery disposal

Do not dispose batteries in household waste. Dispose of batteries only at suitable collection points and, in the case of lithium batteries, cover the battery terminals with electrical tape or other electrically insulating material. The lithium-ion battery must be collected, recycled or disposed of in an environmentally sound manner.

**Warning!**

Air transport warning

Follow the airline transportation baggage regulation in use for the lithium-ion battery pack device.

**Warning!**

Risk of explosion or burns

This device includes a lithium-ion battery pack. To reduce the risk of fire or burns, do not attempt to open, disassemble, or service the battery pack. Do not crush, puncture, short external contacts, or dispose of in fire or water. Only use the device in temperatures between 0 °C (32 °F) and 35 °C (95 °F). Recycle or dispose of properly.

1.3**Suspension****Warning!**

Do not suspend this product in any other manner than explicitly described in this manual, or Electro-Voice installation guides. Do NOT use handles to suspend the loudspeaker. Handles on Electro-Voice loudspeakers are intended to only be used for temporary transport by people. Items, such as fiber rope, wire rope, cables, or other types of materials cannot be used to suspend loudspeaker from the handles.

1.4**FCC information**

IMPORTANT: Do not modify this unit! Changes or modifications not expressly approved by the manufacturer could void the user's authority, granted by the FCC, to operate the equipment.

**Notice!**

This equipment has been tested and found to comply with the limits for a Class B digital device, pursuant to Part 15 of the FCC Rules. These limits are designed to provide reasonable protection against harmful interference in a residential installation. This equipment generates, uses and can radiate radio frequency energy and, if not installed and used in accordance with the instructions, may cause harmful interference to radio communications. However, there is no guarantee interference will not occur in a particular installation.

If this equipment does cause harmful interference to radio or television reception or receive audible interference from radio, television or communications equipment, which can be determined by turning the equipment off and on. The user is encouraged to try to correct the interference by one or more of the following measures:

- Reorient or relocate the receiving antenna.
- Increase the separation between the equipment and receiver.
- Connect the equipment into an outlet on a circuit different from that to which the receiver is connected.
- Consult the dealer or an experienced radio/TV/communications equipment technician.

The device has been granted by FCC and IC, the FCC ID:ESVEVERSE and IC:1249A-EVERSE8.

Please take attention that changes or modification not expressly approved by the party responsible for compliance could void the user's authority to operate the equipment.

This equipment should be installed and operated with a minimum distance of 20 cm between the radiator and your body.

This device complies with Industry Canada license-exempt RSS standard(s). Operation is subject to the following two conditions:

- (1) this device may not cause interference, and
- (2) this device must accept any interference, including interference that may cause undesired operation of the device.

Le présent appareil est conforme aux CNR d'Industrie Canada applicables aux appareils radioexempts de licence. L'exploitation est autorisée aux deux conditions suivantes :

- (1) l'appareil ne doit pas produire de brouillage, et

(2) L'utilisateur de l'appareil doit accepter tout brouillage radioélectrique subi, même si le brouillage est susceptible d'en compromettre le fonctionnement.

Under Industry Canada regulations, this radio transmitter may only operate using an antenna of a type and maximum (or lesser) gain approved for the transmitter by Industry Canada. To reduce potential radio interference to other users, the antenna type and its gain should be so chosen that the equivalent isotropically radiated power (e.i.r.p.) is not more than that necessary for successful communication.

Conformément à la réglementation d'Industrie Canada, le présent émetteur radio peut fonctionner avec une antenne d'un type et d'un gain maximal (ou inférieur) approuvé pour l'émetteur par Industrie Canada. Dans le but de réduire les risques de brouillage radioélectrique à l'intention des autres utilisateurs, il faut choisir le type d'antenne et son gain de sorte que la puissance isotrope rayonnée équivalente (p.i.r.e.) ne dépasse pas l'intensité nécessaire à l'établissement d'une communication satisfaisante.

1.5

Simplified Declaration of Conformity (sDoC)

BG	С настоящото Bosch Security Systems, LLC декларира, че този тип радиосъоръжение EVERSE8-EU, EVERSE8-W е в съответствие с Директива 2014/53/ЕС. Цялостният текст на ЕС декларацията за съответствие може да се намери на следния интернет адрес: www.electrovoice.com
CS	Tímto Bosch Security Systems, LLC prohlašuje, že typ rádiového zařízení EVERSE8-EU, EVERSE8-W je v souladu se směrnicí 2014/53/EU. Úplné znění EU prohlášení o shodě je k dispozici na této internetové adrese: www.electrovoice.com
DA	Hermed erklærer Bosch Security Systems, LLC, at radioudstyrstypen EVERSE8-EU, EVERSE8-W er i overensstemmelse med direktiv 2014/53/EU. EU-overensstemmelseserklæringens fulde tekst kan findes på følgende internetadresse: www.electrovoice.com
DE	Hiermit erklärt Bosch Security Systems, LLC, dass der Funkanlagentyp EVERSE8-EU, EVERSE8-W der Richtlinie 2014/53/EU entspricht. Der vollständige Text der EU-Konformitätserklärung ist unter der folgenden Internetadresse verfügbar: www.electrovoice.com
EL	Με την παρούσα ο/η Bosch Security Systems, LLC, δηλώνει ότι ο ραδιοεξοπλισμός EVERSE8-EU, EVERSE8-W πληροί την οδηγία 2014/53/ΕΕ. Το πλήρες κείμενο της δήλωσης συμμόρφωσης ΕΕ διατίθεται στην ακόλουθη ιστοσελίδα στο διαδίκτυο: www.electrovoice.com
EN	Hereby, Bosch Security Systems, LLC declares that the radio equipment type EVERSE8-EU, EVERSE8-W is in compliance with Directive 2014/53/EU and the relevant statutory requirements. The full text of the EU declaration of conformity and the UK declaration of conformity are available at the following internet address: www.electrovoice.com .
ES	Por la presente, Bosch Security Systems, LLC declara que el tipo de equipo radioeléctrico EVERSE8-EU, EVERSE8-W es conforme con la Directiva 2014/53/UE. El texto completo de la declaración UE de conformidad está disponible en la dirección Internet siguiente: www.electrovoice.com .

ET	Käesolevaga deklareerib Bosch Security Systems, LLC , et käesolev raadioseadme tüüp EVERSE8-EU, EVERSE8-W vastab direktiivi 2014/53/EL nõuetele. Eli vastavusdeklaratsiooni täielik tekst on kättesaadav järgmisel internetiaadressil: www.electrovoice.com
FI	Bosch Security Systems, LLC vakuuttaa, että radiolaitetyyppi EVERSE8-EU, EVERSE8-W on direktiivin 2014/53/EU mukainen. EU-vaatimustenmukaisuusvakuutuksen täysimittainen teksti on saatavilla seuraavassa internetosoitteessa: www.electrovoice.com
FR	Le soussigné, Bosch Security Systems, LLC , déclare que l'équipement radioélectrique du type EVERSE8-EU, EVERSE8-W est conforme à la directive 2014/53/UE. Le texte complet de la déclaration UE de conformité est disponible à l'adresse internet suivante: www.electrovoice.com
HR	Bosch Security Systems, LLC ovime izjavljuje da je radijska oprema tipa EVERSE8-EU, EVERSE8-W u skladu s Direktivom 2014/53/EU. Cjeloviti tekst EU izjave o sukladnosti dostupan je na sljedećoj internetskoj adresi: www.electrovoice.com
HU	Bosch Security Systems, LLC igazolja, hogy a EVERSE8-EU, EVERSE8-W típusú rádióberendezés megfelel a 2014/53/EU irányelvnek. Az EU-megfelelőségi nyilatkozat teljes szövege elérhető a következő internetes címen: www.electrovoice.com
IT	Il fabbricante, Bosch Security Systems, LLC , dichiara che il tipo di apparecchiatura radio EVERSE8-EU, EVERSE8-W è conforme alla direttiva 2014/53/UE. Il testo completo della dichiarazione di conformità UE è disponibile al seguente indirizzo Internet: www.electrovoice.com
LT	Aš, Bosch Security Systems, LLC , patvirtinu, kad radijo įrenginių tipas EVERSE8-EU, EVERSE8-W atitinka Direktyvą 2014/53/ES. Visas ES atitikties deklaracijos tekstas prieinamas šiuo interneto adresu: www.electrovoice.com
LV	Ar šo Bosch Security Systems, LLC deklarē, ka radioiekārta EVERSE8-EU, EVERSE8-W atbilst Direktīvai 2014/53/ES. Pilns ES atbilstības deklarācijas teksts ir pieejams šādā interneta vietnē: www.electrovoice.com
MT	B'dan, Bosch Security Systems, LLC , niddikjara li dan it-tip ta' tagħmir tar-radju EVERSE8-EU, EVERSE8-W huwa konformi mad-Direttiva 2014/53/UE. It-test kollu tad-dikjarazzjoni ta' konformità tal-UE huwa disponibbli f'dan l-indirizz tal-Internet li ġej: www.electrovoice.com
NL	Hierbij verklaar ik, Bosch Security Systems, LLC , dat het type radioapparatuur EVERSE8-EU, EVERSE8-W conform is met Richtlijn 2014/53/EU. De volledige tekst van de EU-conformiteitsverklaring kan worden geraadpleegd op het volgende internetadres: www.electrovoice.com
PL	Bosch Security Systems, LLC niniejszym oświadcza, że typ urządzenia radiowego EVERSE8-EU, EVERSE8-W jest zgodny z dyrektywą 2014/53/UE. Pełny tekst deklaracji zgodności UE jest dostępny pod następującym adresem internetowym: www.electrovoice.com
PT	O(a) abaixo assinado(a) Bosch Security Systems, LLC declara que o presente tipo de equipamento de rádio EVERSE8-EU, EVERSE8-W está em conformidade com a Diretiva 2014/53/UE. O texto integral da declaração de conformidade está disponível no seguinte endereço de Internet: www.electrovoice.com

RO	Prin prezenta, Bosch Security Systems, LLC declară că tipul de echipamente radio EVERSE8-EU, EVERSE8-W este în conformitate cu Directiva 2014/53/UE. Textul integral al declarației UE de conformitate este disponibil la următoarea adresă internet: www.electrovoice.com
SK	Bosch Security Systems, LLC týmto vyhlasuje, že rádiové zariadenie typu EVERSE8-EU, EVERSE8-W je v súlade so smernicou 2014/53/EÚ. Úplné EÚ vyhlásenie o zhode je k dispozícii na tejto internetovej adrese: www.electrovoice.com
SL	Bosch Security Systems, LLC potrjuje, da je tip radijske opreme EVERSE8-EU, EVERSE8-W skladen z Direktivo 2014/53/EU. Celotno besedilo izjave EU o skladnosti je na voljo na naslednjem spletnem naslovu: www.electrovoice.com
SV	Härmed försäkrar Bosch Security Systems, LLC att denna typ av radioutrustning EVERSE8-EU, EVERSE8-W överensstämmer med direktiv 2014/53/EU. Den fullständiga texten till EU-försäkran om överensstämmelse finns på följande webbadress: www.electrovoice.com





For Europe:

Frequency band of operation 2400 to 2483.5 MHz.

Maximum transmit power less than 20 dBm EIRP.

1.6

Precautions

	If an Electro-Voice loudspeaker is used outdoors on a sunny day, place the loudspeaker in a shaded or covered area. The loudspeaker amplifiers have protection circuits that temporarily shut the loudspeaker off when extremely high temperatures are reached. This can happen on hot days when the loudspeaker is in direct sunlight.
	Do not use Electro-Voice loudspeakers in an environment where temperatures are below 0 °C (32 °F) or exceed +35 °C (95 °F).
	Electro-Voice loudspeakers are easily capable of generating sound pressure levels sufficient to cause permanent hearing damage to anyone within normal coverage distance. Caution should be taken to avoid prolonged exposure to sound pressure levels exceeding 90 dB.
	Do not store EVERSE batteries in an environment where temperatures are below -20 °C (-4 °F) or exceed 45 °C (113 °F).

1.7

Certifications

Argentina:



Certificate number: RA 4184063 E

Brazil:

Após uma perturbação da rede elétrica, o EVERSE pode entrar em estado de segurança. Neste caso, você deve desligar e ligar o dispositivo novamente.

Este equipamento não tem direito à proteção contra interferência prejudicial e não pode causar interferência em sistemas devidamente autorizados.

Para mais informações, consulte o site da ANATEL: www.anatel.gov.br.

Cambodia:

TRC Identifier: RF-TA-2022-0373

Malaysia:**Mexico:**

“La operación de este equipo está sujeta a las siguientes dos condiciones: (1) es posible que este equipo o dispositivo no cause interferencia perjudicial y (2) este equipo o dispositivo debe aceptar cualquier interferencia, incluyendo la que pueda causar su operación no deseada”



IFETEL ID: ROELEV22-22223

Pakistan:

Republic of Korea:**R-R-B6S-ESVEVERSE**

기자재명칭:	특정소출력 무선기기(무선데이터통신시스템용 무선기기)
모델명:	EVERSE 8
정격:	100-240 Vac, 50-60 Hz, 1000 W
수입업체 (상호)명:	로버트보쉬코리아(유)
제조사:	Bosch Security Systems, LLC.
제조연월:	별도표기
제조국:	중국
A/S:	02-702-2846

해당 무선설비는 운용 중 전파혼신 가능성이 있음

해당 무선설비는 전파혼신 가능성이 있으므로 인명안전과 관련된 서비스는 할 수 없습니다.

Thailand:



เครื่องวิทยุคมนาคมนี้ ได้รับยกเว้น ไม่ต้องได้
รับใบอนุญาตให้มี ใช้ซึ่งเครื่องวิทยุคมนาคม
หรือตั้งสถานีวิทยุคมนาคมตามประกาศ กสทช.
เรื่อง เครื่องวิทยุคมนาคม และสถานีวิทยุ
คมนาคมที่ได้รับยกเว้นไม่ต้องได้รับใบอนุญาต
วิทยุคมนาคมตามพระราชบัญญัติวิทยุคมนาคม
พ.ศ. 2498



nanb. | โทรคมนาคม
กำกับดูแลเพื่อประชาชน
Call Center 1200 (InswS)

United Arab Emirates:

TDRA - UNITED ARAB Emirates

Dealer ID: DA45733/15
TA RTE: ER10360/22
Model Name: EVERSE 8
Product Type: Bluetooth

**1.8****Notices****Copyright and disclaimer**

All rights reserved. No part of this document may be reproduced or transmitted in any form by any means, electronic, mechanical, photocopying, recording, or otherwise, without the prior written permission of the publisher. For information on getting permission for reprints and excerpts, contact Electro-Voice.

All content including specifications, data, and illustrations in this manual are subject to change without prior notice.

**Notice!**

Bluetooth® is available in selected countries.

Contact your nearest Electro-Voice dealer or Electro-Voice distributor for more information.

The Bluetooth® word mark and logos are registered trademarks owned by Bluetooth SIG, Inc. and any use of such marks by Bosch Security Systems, LLC is under license. Other trademarks and trade names are those of their respective owners.

Importer and after-sales service**China**

Bosch (Shanghai) Security Systems Ltd.
333 Fuquan Road North IBP
Changning District Shanghai
200335 P.R. China

博世（上海）安保系统有限公司
上海市长宁区虹桥临空经济园区，福泉北路333号

EU

Bosch Sicherheitssysteme GmbH
Robert-Bosch-Ring 5
85630 Grasbrunn
Germany

Mexico

Robert Bosch de R.L de C.V.
Calle Robert Bosch No. Ext. 405
C.P.50071
Zona industrial Toluca
Mexico
Phone: +52 722 279 2300

UK

Robert Bosch Ltd.
Broadwater Park
North Orbital Road
Uxbridge UB9 5HJ
UK

2 Description

Thank you for choosing an Electro-Voice powered loudspeaker system. Please take time to consult the manual to understand all the features built into your Electro-Voice system and fully utilize its performance capabilities.

The EVERSE 8 is a versatile, easy to use, compact, battery-powered loudspeaker system. It provides professional level performance and is housed in a robust weatherized enclosure. The EVERSE 8 provides real professional performance for musical performances, voice reinforcement and audio playback. The EVERSE 8 takes advantage of decades of Electro-Voice and Dynacord pro-audio and electronics expertise, along with new advancements in technology, to provide truly portable and truly wireless audio.

The EVERSE 8 utilizes a 2-way configuration with an 8-inch woofer. It includes a hi-output, titanium, ferro-fluid cooled tweeter, featuring a high-energy neodymium magnet for maximum output and reduced weight. The tweeter is mounted to an Electro-Voice patented SST constant directivity waveguide design, producing exceptionally high SPL with even 100° x 100° coverage and improved acoustic alignment and bass extension.

The rugged polypropylene enclosure features a weatherized input cover for the input section, allowing the loudspeaker to meet IP43 rating (splash and light rain resistant) for use on battery power and Bluetooth® streaming. The available accessory slipcover allows for additional weather resistance and protection when needed.

The EVERSE 8 features Electro-Voice's QuickSmart DSP and is **POWERED BY DYNACORD**, featuring a built-in 4-channel digital mixer with FX, feedback suppression, and ducking features. The loudspeaker features a custom designed, and fully optimized for audio use, high capacity battery pack. The battery pack provides more than enough power to complete the show, including a 12 V DC accessory port to power RE3 or R300 wireless microphone systems. The EVERSE 8 is available in both white and black.

2.1 Short information

The following table lists products in the EVERSE family, with CTN (Commercial Type Number) and identifying product name DESCRIPTION.

CTN	Description
EVERSE8-US	8" 2-way speaker battery black US
EVERSE8-EU	8" 2-way speaker battery black EU
EVERSE8-W	8" 2-way speaker battery white US&EU
EVERSE8-TRAY-B	Tray for EVERSE 8, 12V DC cable black
EVERSE8-TRAY-W	Tray for EVERSE 8, 12V DC cable white
EVERSE8-RAINCVR	Rain resistant cover for EVERSE 8
EVERSE8-TOTE	Padded tote bag for EVERSE 8
EVERSE8-BAT-B	Battery pack assembly, EVERSE8, black
EVERSE8-BAT-W	Battery pack assembly, EVERSE8, white

2.2 System features

EVERSE8-US/EVERSE8-EU/EVERSE8-W





- **Long run-time removable and replaceable battery pack**
The EVERSE 8 battery pack will provide 6+ hours of constant music playback at maximum output levels, or over 12+ hours at 95 dB SPL average. The EVERSE 8 has integrated power saving features to extend battery life when no signal is present. The 12 V DC jack on the EVERSE 8 loudspeaker can be used to power a wireless microphone receiver like the Electro-Voice RE3 or R300.
- **Real professional level output and Electro-Voice sound quality**
The EVERSE 8 features an 8-inch woofer with SST port and a 1-inch titanium dome tweeter which produces over 121 dB SPL max, from 50 Hz to 20 kHz. The 100° x 100° wave guide ensures even coverage across all frequencies. Two additional monitor angles (30° and 55°) ensure the right coverage and position for any situation.
- **Easy to use with QuickSmart Mobile app and Electro-Voice's Intuitive User Interface**
The EVERSE features Electro-Voice's intuitive QuickSmart DSP with single encoder and push key interface for simple and quick setup. EVERSE can be paired via Bluetooth® to a mobile device with the QuickSmart Mobile app installed to provide easy remote control of all audio functions. The QuickSmart Mobile app allows pairing and grouping of up to six loudspeakers, in any combination, including EVERSE 8 , ELX200 powered family, and the EVOLVE family.
- **High Quality Stereo Bluetooth® streaming**
The EVERSE 8 features Bluetooth® streaming. Two EVERSE 8 loudspeakers can be paired for true wireless stereo (TWS) streaming from a mobile device.
- **POWERED BY DYNACORD with built-in digital 4-channel mixer**
The EVERSE 8 features a built-in 4-channel mixer with FX, EQ, automatic feedback suppression and ducking functions. The mixer includes two XLR/TRS combo jacks, including 48V phantom power on **INPUT 1** (XLR) and Hi-Z compatibility on **INPUT 2** (TRS). The mixer also includes Stereo Bluetooth® and 3.5 mm connections.
- **Auto-Standby**
The EVERSE 8 offers an automatic standby function after 15 minutes without signal. This extends the battery runtime in case the loudspeaker is not being used. The loudspeaker can be re-activated to full operation by pressing a button on the panel or with the app.

2.3 Quick setup

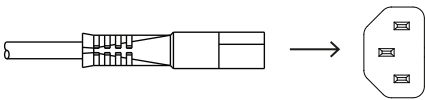
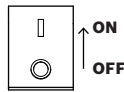
Full-range loudspeaker

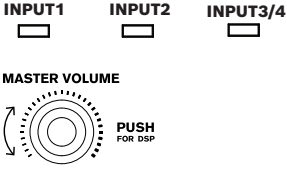
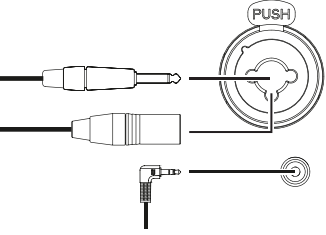
To set up the loudspeaker:

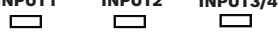
Step	Illustration
1. Connect the AC power cord from a grounded receptacle to the MAINS IN to ensure the battery has sufficient charge. Note: It is recommended to leave the loudspeaker plugged in and charging for 24 hours the first time it is used.	
2. Switch power to ON .	

<p>3. Adjust the volume (VOL) to 0 dB using the MASTER VOL knob.</p>	<p>MASTER VOLUME</p> 
<p>4. Push the input selection soft key for INPUT 1 or INPUT 2 if using an XLR or TRS cable, or push the input selection soft key for INPUT 3/4 if using 3.5 mm mini jack. Use the MASTER VOL knob to adjust INPUT LEVEL to MUTE.</p>	<p>INPUT1 INPUT2 INPUT3/4</p> 
<p>5. Connect an audio source using an XLR or TRS cable to INPUT 1, INPUT 2, or a 3.5 mm mini jack to INPUT 3/4. Ensure audio source is MUTE or at a low level before making connection. After connection is made, increase the source's output to a reasonable level.</p>	
<p>6. Adjust the INPUT LEVEL until the signal peaks are just below maximum level or the required output is achieved. If CLIP is indicated, turn the level down until the CLIP indication disappears. Press the input selection soft key again to exit the channel menu.</p>	<p>MASTER VOLUME</p>  <p>INPUT1 INPUT2 INPUT3/4</p> 
<p>7. Using the MASTER VOL knob, adjust the volume (VOL) until you get the required output from the loudspeaker.</p>	<p>MASTER VOLUME</p> 

3 Pairing the QuickSmart Mobile app

The EV QuickSmart Mobile app for tablets and smartphones is available for download from the iTunes App Store and the Google Play Store.



Notice!

The EV QuickSmart Mobile app is designed to only find loudspeakers from Electro-Voice featuring Bluetooth® control functionality.

The EV QuickSmart Mobile app will not display other types of Bluetooth® devices, e.g. phones, laptops, tablets, or headsets.

Prior to pairing the EV QuickSmart Mobile app with Electro-Voice loudspeakers:

1. Ensure that Bluetooth® is enabled on the smartphone or tablet.
2. Ensure that pairing mode is enabled on the loudspeaker.

To place the loudspeaker in pairing mode for both control and streaming:

1. Press and hold **INPUT 3/4** until **Pairing Mode On** and the 4-digit ID is shown on the LCD. Pairing mode can be enabled through the LCD menu for control and streaming separately.

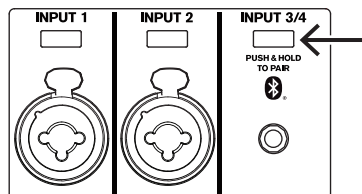

2. Navigate to your mobile device's Bluetooth® settings menu, find the EVERSE loudspeaker with the matching 4-digit ID and ensure you are paired to the loudspeaker. This will pair the mobile device to the EVERSE loudspeaker for audio streaming.
3. Continue to the next step to pair for control.



Notice!

For Android devices ensure location services are allowed. Electro-Voice does not collect, store, or track user location data or personal information.

First time pairing

1. Open the EV QuickSmart Mobile app. 
2. **Select your Speakers** is displayed on the screen. The EV QuickSmart Mobile app is looking for available Bluetooth® enabled Electro-Voice loudspeakers. The available loudspeakers are displayed on the screen.
3. Tap the loudspeaker you want to pair with the app. The selected loudspeaker will have a line under it acknowledging it is selected.
4. Repeat the previous step until all of the required loudspeakers are selected.
5. Tap the **CONNECT** button.

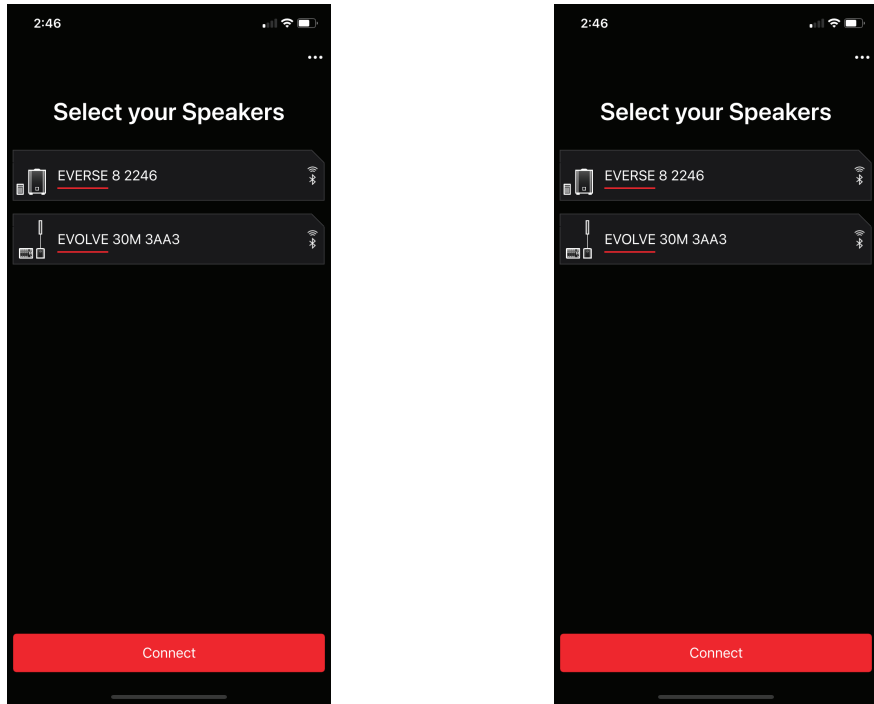

- 6. The app connects with the required loudspeaker. You will get a message from iOS/iPadOS/Android about pairing for each device which has to be accepted.
- 7. Tap **PAIR** on the device to accept pairing to the loudspeakers. The app can connect to up to six loudspeakers.

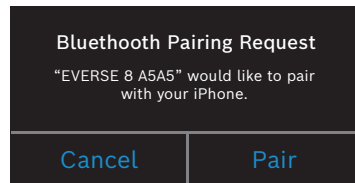

Subsequent pairing

To pair additional loudspeakers with the EV QuickSmart Mobile app:

- 1. Tap the EV QuickSmart Mobile app icon. 
- 2. **Select your Speakers** is displayed on the screen. The EV QuickSmart Mobile app is looking for available Bluetooth® enabled Electro-Voice loudspeakers. The available loudspeakers are displayed on the screen.
- 3. Tap the loudspeaker you want to pair with the app. The selected loudspeaker will have a line under it acknowledging it is selected.
- 4. Repeat the previous step until all of the required loudspeakers are selected.

5. Tap the **CONNECT** button.
The app connects with the required loudspeaker.
The app can connect to up to six loudspeakers.

4 Operation

4.1 Installation and charging of battery pack



The EVERSE 8 comes pre-installed with a high capacity Li-Ion battery pack. Charge the battery for 24 hours before the first use to ensure maximum battery run time and life expectancy.

To charge the battery:

- ▶ Plug the **MAINS IN** while the battery is installed in the EVERSE 8 .

After the first full charge, the expected battery charge times are as follows:

- 4 hours or less with no signal and the power switched off.
- 6 hours or less with the power switched on and audio playing at high output levels.

The LCD will display  **CHARGING** while the battery is charging with the power switched off. The LCD will display  **FULL** when the battery has reached full charge.

Notice!

Battery self-discharge

All Li-Ion batteries experience self-discharge over extended periods (several months). If a battery sits for an extended period without being charged, the battery may fully discharge. It may take longer than normal to fully recharge. If this occurs, allow the battery to charge a full 24 hours again before using.

Inspect your loudspeaker and battery monthly and recharge the battery. This will help maintain the batteries run time and extend its useful life.



To remove and reinstall the battery for inspection or replacement:

1. Place the loudspeaker grille side down with the battery door facing you on a flat non-scratching surface such as a workbench with a rubber mat.
2. Fully loosen the two finger tab screws by turning them counter-clockwise.
3. Gently but firmly pull on the battery pack by the finger pull located on the back of the battery door.

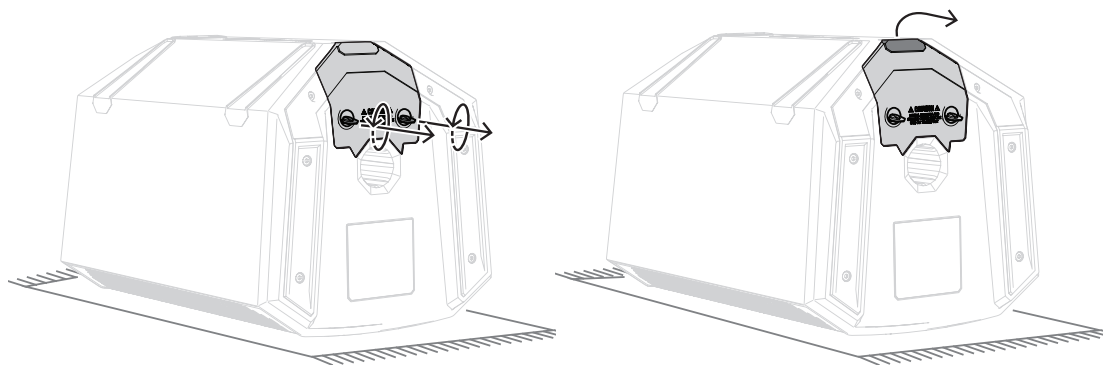

4. To reinstall the battery pack, follow the previous steps in reverse.



Notice!

Ensure that the battery door is fully seated before tightening the finger tab screws. Finger tighten only until snug. Do not over tighten or use excessive torque. This may cause damage.

4.2 Weatherization

When the weatherized input cover is installed, the EVERSE 8 loudspeaker is designed to be weather resistant to IP 43 standards, but not waterproof. The weather resistance may be reduced by damage, repair, improper disassembly, and regular wear and tear. Always inspect the EVERSE 8 and accessories before and after every use. Allow the loudspeaker and components to dry before storage or between uses.

The EVERSE 8 loudspeaker with weatherized input cover installed is intended only for temporary use in wet or damp environments. The loudspeaker is not intended to be exposed continuously to moisture over long periods of time. Do not expose to salt water or spray, do not expose to chlorine or use in high chlorine environments.

To use the loudspeaker in wet and damp environments safely:

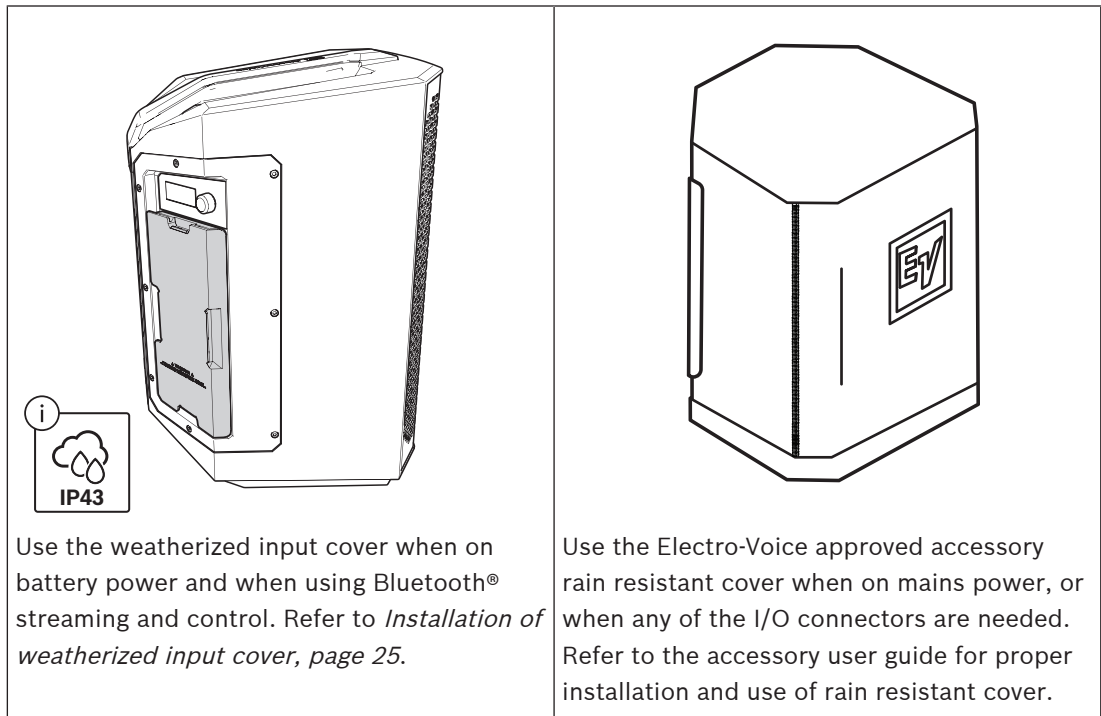

Warning!



Only use EVERSE products in the manner explicitly called out in this section. Failure to do so may result in product failure or serious injury.



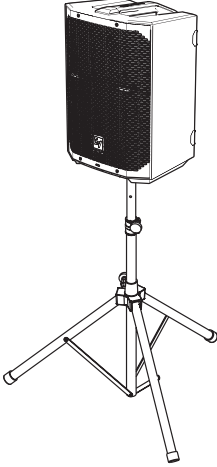

Warning!

Only use Electro-Voice approved accessories.

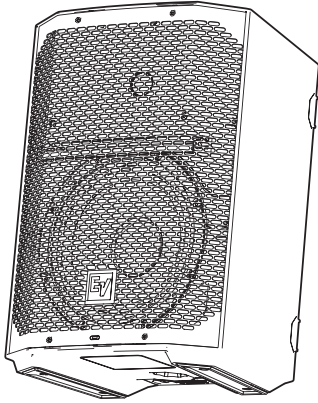
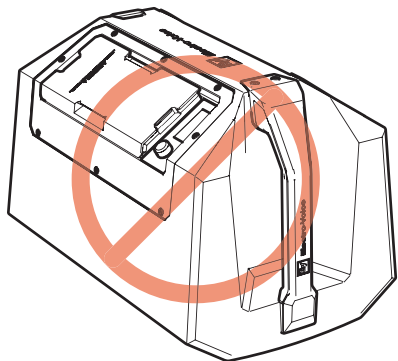
Using the loudspeaker in damp or wet environments

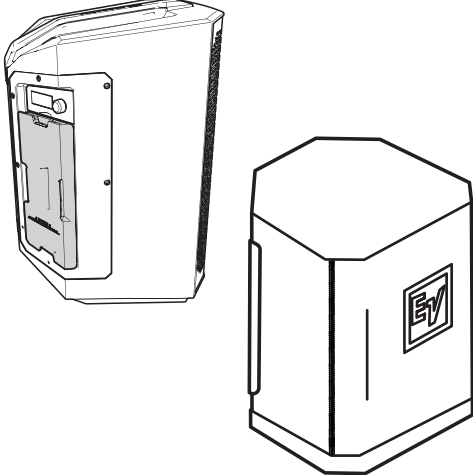
Correct	Incorrect
<p data-bbox="392 293 911 357">Place the loudspeaker on an elevated, level, stable surface, or on a tripod.</p> 	<p data-bbox="943 293 1477 357">DO NOT place the loudspeaker in a puddle or standing water.</p> 
<p data-bbox="392 900 919 963">Always orient the loudspeaker upright, in the KICKBACK mode, or in the MONITOR mode.</p> 	<p data-bbox="943 900 1453 1002">DO NOT place or transport the loudspeaker upside down, or on the amp panel side to prevent water ingress.</p> 

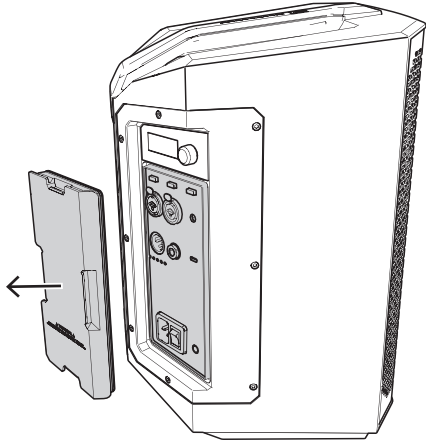
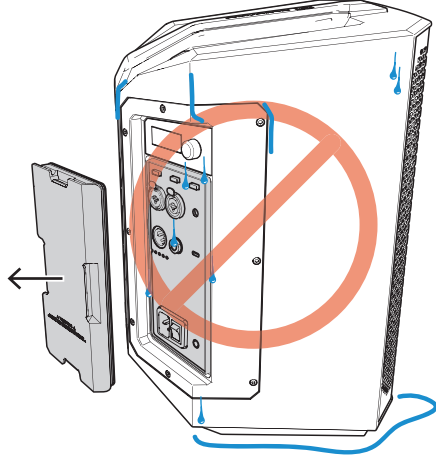
Correct	Incorrect
<p>Always use the supplied weatherized input cover (refer to <i>Installation of weatherized input cover, page 25</i>) or the Electro-Voice approved accessory rain resistant cover in wet or damp environments.</p> 	<p>DO NOT use the EVERSE 8 loudspeaker in damp or wet environments without the weatherized input cover or the accessory rain resistant cover.</p> 
<p>Dry the product and the weatherized input cover after use, prior to removing the weatherized input cover.</p> 	<p>DO NOT remove the weatherized input cover while wet. If so, water may access the IO panel.</p> 

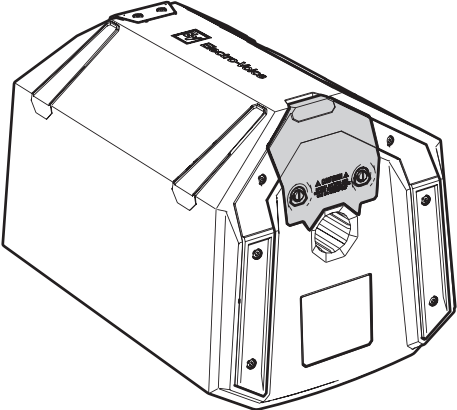
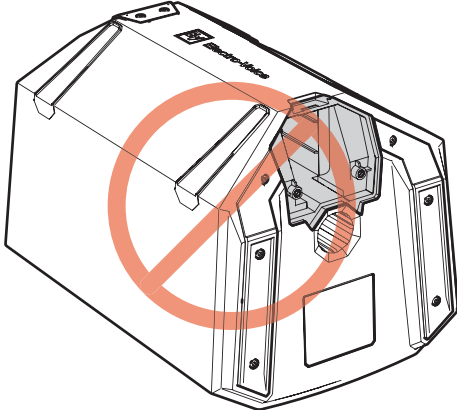
Correct	Incorrect
<p>Always ensure the battery is properly installed when operating in a wet or damp environment.</p> 	<p>DO NOT use in wet or damp environments when the battery is not installed. This may result in moisture entering the battery bay.</p> 

4.3 Installation of weatherized input cover

The weatherized input cover must be installed when the EVERSE 8 loudspeaker is intended to be used in wet or damp conditions. When the weatherized input cover is installed, the EVERSE 8 loudspeaker will be water resistant to IP43 standards. The EVERSE 8 loudspeaker is able to operate under battery power and Bluetooth® streaming for audio, and control with the weatherized input cover installed.

To install the weatherized input cover:

1. Ensure that the weatherized input cover is fully intact, dry, clean and the gasket is in good condition.
2. Ensure that the input panel on the EVERSE 8 loudspeaker is dry, clean, and the mating channel around the input connectors is dry and free of any dust or debris that would prevent a good seal.

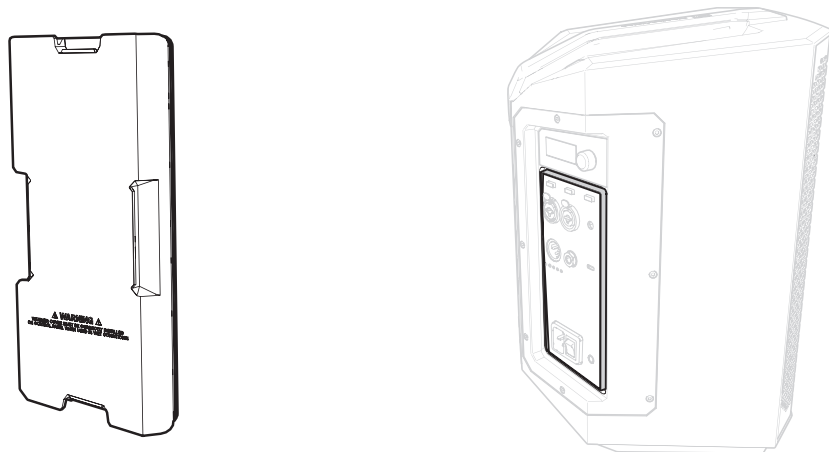

3. Power on the loudspeaker.

4. Install the weatherized input cover by pressing it firmly in order to fully seat the gasket in the mating channel on the amplifier input panel.
The weatherized input cover will be flush with the adjacent panels of the loudspeaker.

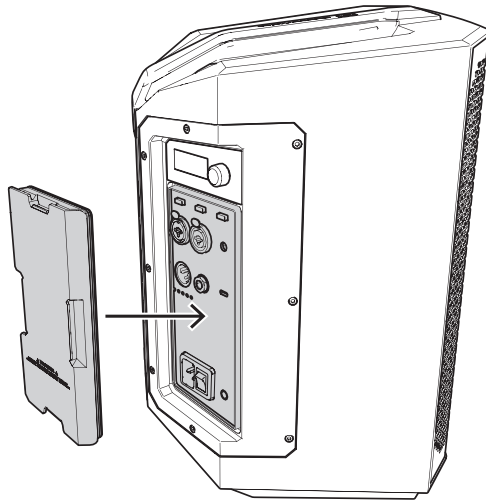

To remove the weatherized input cover:

- ▶ Pull the cover carefully and evenly using the finger pull-tabs.

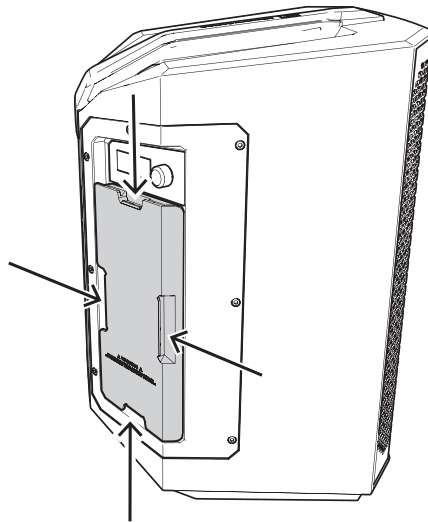

4.4

Tripod or pole mount

EVERSE 8 loudspeakers mount on a tripod stand or on a pole above a subwoofer.

Mounting a loudspeaker on a tripod stand



Caution!

Tripod is not evaluated for safety with this loudspeaker. Check the specifications of the tripod stand to be certain it is capable of supporting the weight of the loudspeaker.

To mount a loudspeaker on a tripod stand:

1. Place the tripod stand on a level and stable surface.
1. Fully extend the legs on the tripod stand.

2. Do not compromise the tripod stand's structural integrity by trying to make the stand taller.
3. Do not attempt to mount more than one loudspeaker on a stand designed for a single loudspeaker.
1. Lift the loudspeaker using two hands.
2. Set the pole cup located on the bottom of the loudspeaker onto the pole.

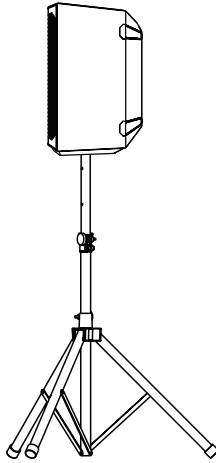

Mounting a loudspeaker on a pole

To mount a loudspeaker on a pole:

1. Place the subwoofer on a level and stable surface.
2. Insert the M20 threaded pole into the combo pole cup on the top of the subwoofer.
3. Turn the M20 threaded pole clockwise to secure the pole to the subwoofer.

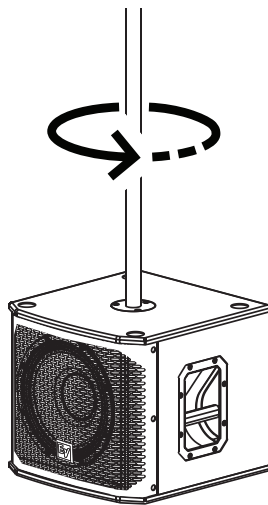

4. Lift the loudspeaker using two hands.
5. Set the loudspeaker location to **TRIPOD** in the DSP control menu.
6. Select the corresponding **LOW PASS** setting for your subwoofer.

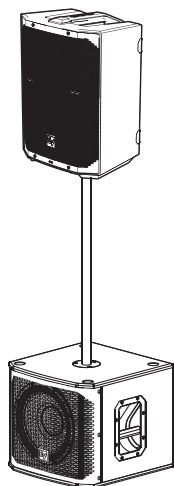
**Notice!**

Select **LOCATION TRIPOD** in menu or app for best sound.

4.5**Floor monitor & kickback**

EVERSE 8 loudspeakers may be used as a floor monitor or in kickback position by placing the loudspeaker on one of the two integral monitor angles.

Setting up a loudspeaker as a floor monitor

To set up a loudspeaker as a floor monitor:

1. Place the loudspeaker on a level and stable surface.
2. Safely route cables to prevent injury to performers, production crew, and audience members.
3. Set the loudspeaker location to **MONITOR** in the DSP control menu.

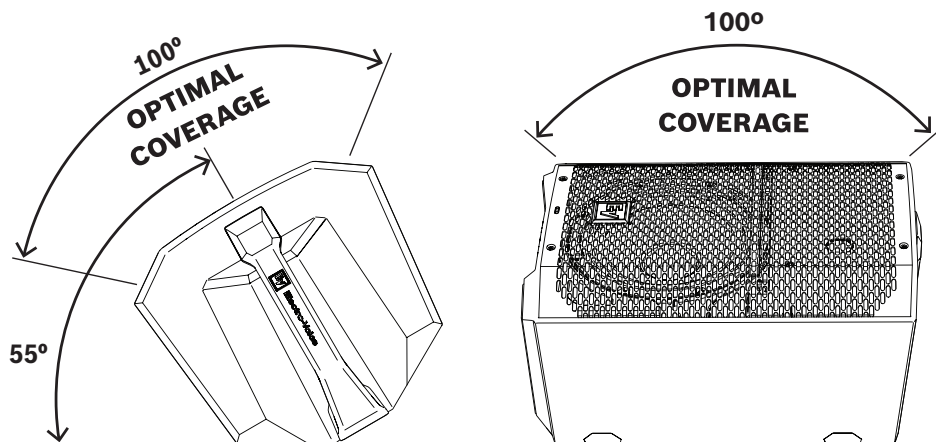

Figure 4.1: Optimum coverage in monitor position (side view left and front view right)

Setting up a loudspeaker in kickback position

To set up a loudspeaker in kickback position:

1. Place the loudspeaker on a level and stable surface.

2. Tilt the loudspeaker rearward to rest securely in the kickback position.
3. Safely route cables to prevent injury to performers, production crew, and audience members.
4. Set the loudspeaker location to **KICKBACK** in the DSP control menu.

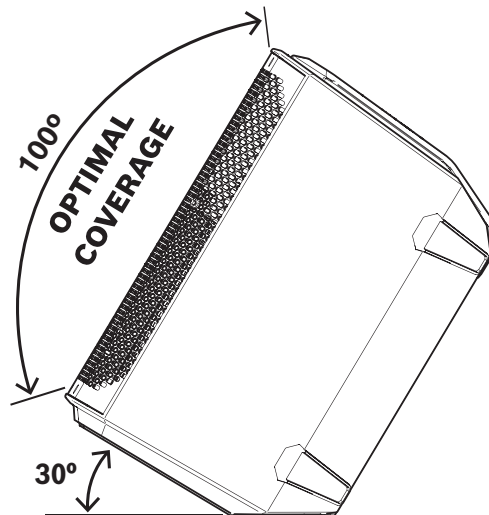

Figure 4.2: Optimum coverage in kickback position.

5 Amplifier DSP

5.1 Amplifier DSP controls

The amplifier has a combination of controls and connectors to ensure the most versatile loudspeaker system.

Loudspeaker control and monitoring interface

These DSP control menu selections are available for the EVERSE .

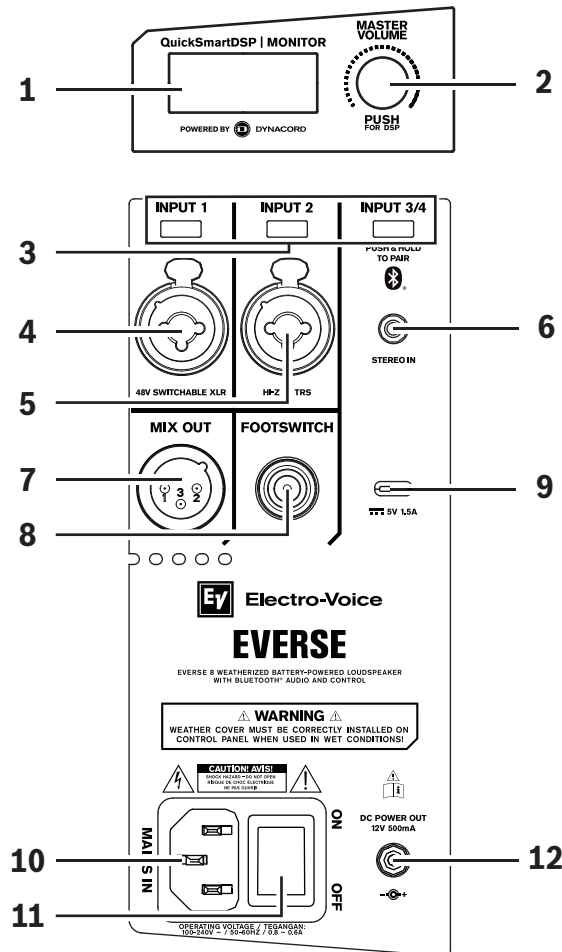

Figure 5.1: Loudspeaker amplifier panel

1. **LCD** – DSP control and monitoring interface.
2. **MASTER VOL** - Adjusts the sound level and navigates the DSP control menu.
DSP - Scroll through the menu and select the available choices. Push the **MASTER VOL** knob to enter the DSP control menu.
3. **Input selection soft keys** - Press the soft key to select the input and access the DSP control menu for the channel. Press the softkey a second time to deselect the channel and return to the main DSP.
4. **INPUT 1** - Balanced INPUT for the connection of signal sources like mixing consoles, instruments, or microphones. Connections can be established using ¼-inch TRS or XLR connectors. The XLR connector is selectable for 48V phantom power.
5. **INPUT 2** - Balanced INPUT for the connection of input sources like mixing consoles, or microphones via XLR connector or Hi-Z instrument connection via TRS.
6. **INPUT 3/4** - Bluetooth® stereo INPUT for audio streaming or analog stereo INPUT via 3.5 mm mini-jack.

7. **MIX OUT** - XLR output sends either the mix of all input signals or the stereo L or stereo R signal to another loudspeaker or subwoofer.
8. **FOOTSWITCH** - ¼-inch TRS connector for connecting footswitch control to toggle FX on/off.
9. **Mobile device charging port** - 5 V 1.5 A charging for mobile devices.
10. **MAINS IN** – AC connection is established via an IEC-connector.
11. **POWER** - Switch for power **ON** or **OFF** of the loudspeaker. The LCD screen lights up when the power is turned **ON**, after approximately three seconds.
12. **DC POWER OUT** - DC power output jack for use with the 5.5 mm outer diameter and 2.5 mm inner diameter DC power cable included with the EVERSE-TRAY accessory. The DC POWER OUT jack is capable of powering a wireless microphone receiver which uses a center pin positive polarity and draws 500mA or less at 12 Volts DC, such as the Electro-Voice RE3 or R300 wireless microphone receiver.



Warning!

The DC power jack is a power output. **THIS IS NOT A CHARGING PORT. DO NOT** connect a DC power adapter or attempt to re-charge the EVERSE loudspeaker’s battery with this connector. Doing so may cause damage to the loudspeaker and void of warranty.

5.2

System status

Normal

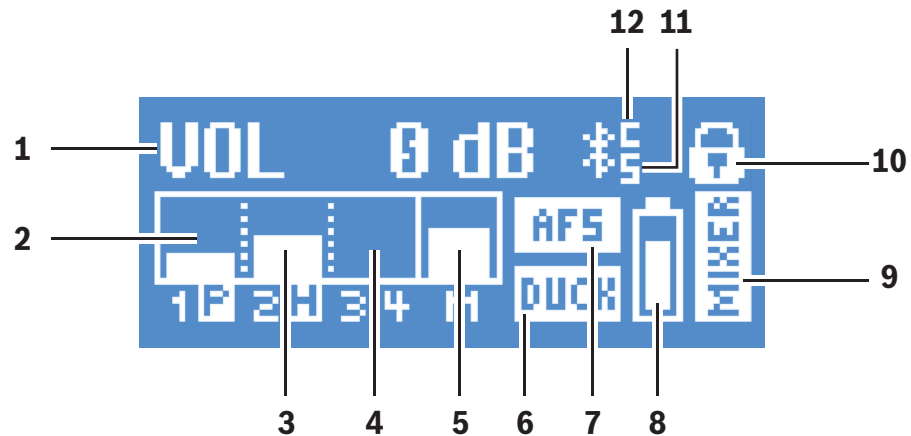

1. **VOL** - Indicates the master gain of the system in dB. The range is from -80 dB to +10 dB, in 1 dB increments.
2. **INPUT 1** - VU meter displays the signal level of INPUT 1 into the amplifier INPUT 1 connector. The display of **P** indicates 48V phantom power is switched on.
3. **INPUT 2** - VU meter displays the signal level of INPUT 2 into the amplifier INPUT 2 connector. The display of **H** indicates Hi-Z instrument connection is present on the INPUT 2 TRS connector.
4. **INPUT 3/4** - VU meter displays the signal level of INPUT 3/4 into the amplifier from either Bluetooth® streaming or 3.5 mm mini jack connection.
5. **MAIN** - VU meter displays the signal level of the MAIN output.
6. **DUCK** - Ducking is activated on either or both INPUT 1 and INPUT 2.
7. **AFS** - Automatic feedback suppression is enabled.
8. **BATTERY status** - Indicates the battery level of the loudspeaker and if the battery is charging (when **MAINS** is connected).
9. **FUNCTION indicator** - Indicates whether the system is in **MIXER** or **BASIC** mode.

10. **Status display** - Alternately shows the following:
 - 1** - Indicates the selected preset number. There are five user-defined presets available.
 - E** - Edited. Indicates the preset is not saved. When the preset is saved, the **E** is not displayed.
 - Lock status** - Indicates that the LCD display and controls are locked. Press the **MASTER VOL** knob or channel select soft key to unlock.
11. **S** - Audio streaming. The available options are:
 - OFF - DISABLED**
 - FLASHING - PAIRING MODE (120s)**
 - SOLID - CONNECTED**
12. **C** - Control app. The available options are:
 - OFF - DISABLED**
 - FLASHING - PAIRING MODE**
 - SOLID - CONNECTED**

System protection

System protection limiters indicate when a system is exceeding recommended usage by indicating input **CLIP** or output **LIMIT** on the LCD display.

CLIP

CLIP indicates that the signal to the loudspeaker is too high, resulting in a clipped signal into the loudspeaker.

If **CLIP** is shown:

- ▶ Reduce the **INPUT GAIN** and/or the signal on the mixer or source equipment.

LIMIT

LIMIT protects the loudspeaker from short-term peaks and long-term overload, which can cause distortion. When **LIMIT** is displayed on the screen, the limiter is active.

If the **LIMIT** indication is shown often or continuously:

- ▶ Reduce the output volume (**MASTER VOL**). This is strongly recommended.



5.3

DSP controls

An integrated DSP control menu allows the user to select multiple DSP system settings on the loudspeaker.

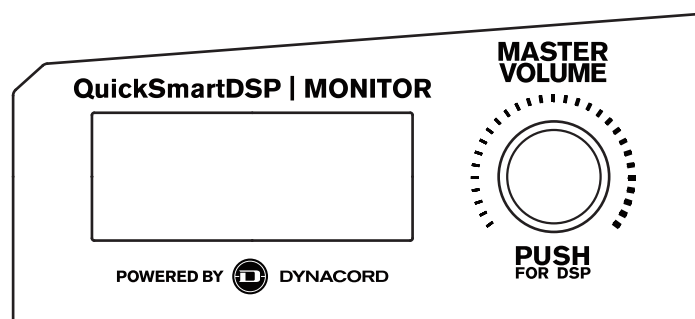

Accessing the DSP control menu

To access the DSP control menu:

1. Push the **MASTER VOL** knob.
The DSP control menu appears.
2. Using the **MASTER VOL** knob, scroll through the menu items.

3. Push the **MASTER VOL** knob to select the menu item you want to modify.
The focus moves to the parameters on the right side of the DSP control menu.
4. Using the **MASTER VOL** knob, scroll through the parameters.
5. Push the **MASTER VOL** knob to confirm the selected parameter.
The setting is saved. The focus returns to the menu items on the left side of the DSP control menu.
6. Repeat steps 2 through 5 to modify additional DSP and system settings.
7. Select **EXIT** to return to the home screen.

5.3.1 Loudspeaker DSP control menu

The loudspeaker DSP control menu selections are available for the EVERSE loudspeakers.

DSP control menu for MIXER mode

VOLUME		0 dB (Default)
		MUTE, -80 dB - +10 dB (1 dB)
	EXIT	
	FUNCTION	MIXER (Default)
		BASIC
	MODE	MUSIC (Default)
		LIVE
		SPEECH
		CLUB
	MAIN LEVEL	0 dB (Default)
		MUTE, -80 dB - +10 dB (1 dB)
	LOCATION	TRIPOD (Default)
		KICKBACK
		MONITOR
	SUB	OFF (Default)
		100 Hz
		120 Hz
		150 Hz
		ELX200-12SP
		ELX200-18SP
		EKX-15SP
		EKX-18SP
TREBLE	0 dB (Default)	

		-12 dB - +6 dB
MID		0 dB (Default)
		-12 dB - +6 dB
BASS		0 dB (Default)
		-12 dB - +6 dB
MAIN PEQ	BACK	
	ENABLE ALL	ON (Default)
		OFF
	RESET ALL	NO (Default)
		YES
	PEQ #	1 (Default)
		1 - 7
	BYPASS	OFF (Default)
		ON
	TYPE	PEQ (Default)
		LOW SHELF
		HI SHELF
		LOW PASS
	Q (PEQ only)	0.7 (Default)
		0.5 - 10.0
	FREQ	120 Hz (Default)
		50 - 20 kHz
GAIN (PEQ, LOW SHELF and HI SHELF only)	0 dB (Default)	
	-12 dB - +6 dB	
RESET	NO (Default)	
	YES	
BACK		
MAIN GEQ	BACK	
	63 Hz	0 dB (Default) -12 dB - +12 dB (1 dB)
	160 Hz	0 dB (Default)

		400 Hz	-12 dB - +12 dB (1 dB)
		1 kHz	0 dB (Default)
		2.5 kHz	-12 dB - +12 dB (1 dB)
		6 kHz	0 dB (Default)
		12 kHz	-12 dB - +12 dB (1 dB)
		RESET	RESET ALL BANDS? YES/NO
		BACK	
	FX	01 (Default)	
		00 to 30	
	FX Delay (FX 20 only)	427 ms (Default)	
		30 ms - 550 ms	
	FX ENABLE	ON (Default)	
		OFF	
	AFS (automatic feedback suppression)	OFF (Default)	
		ON	
	MIX OUT	L+R (Default)	
		L	
		R	
	BLUETOOTH	BACK	
		BLUETOOTH	ON (Default)
			OFF
		ID (4-digit unique device number)	
		CONTROL PAIR	
		AUDIO PAIR	
		LINK SPEAKERS	
		LINK ROUTE	L+R (Default)
			L
			R
		BACK	
	LED	ON (Default)	
		OFF	

		LIMIT
DISPLAY	BACK	
	LCD DIM	ON (Default)
		OFF
	BRIGHT	5 (Default)
		1 - 10
	CONTRAST	5 (Default)
1 - 10		
BACK		
STORE		BACK, 1, 2, 3, 4, 5, BACK
RECALL		BACK, 1, 2, 3, 4, 5, 6 (Default), BACK
STANDBY		15 min (Default)
		15 min - 60 min, OFF
RESET	DEFAULT SETTINGS?	NO (Default)
		YES
	ERASE USER PRESETS?	NO (Default)
		YES
INFO		[FIRMWARE VERSION]
		©2021 Electro-Voice
EXIT		

Table 5.1: Loudspeaker DSP control menu MIXER mode

DSP control menu for BASIC mode

VOLUME		0 dB (Default)
		MUTE, -80 dB - +10 dB (1 dB)
	EXIT	
	FUNCTION	MIXER (Default)
		BASIC
	MODE	MUSIC (Default)
LIVE		

			SPEECH
			CLUB
	LOCATION		TRIPOD (Default)
			KICKBACK
			MONITOR
	SUB		OFF (Default)
			100 Hz
			120 Hz
			150 Hz
			ELX200-12SP
			ELX200-18SP
			EKX-15SP
			EKX-18SP
	DELAY		OFF (Default)
			0.1 m - 100.0 m
	TREBLE		0 dB (Default)
			-12 dB - +6 dB
	MID		0 dB (Default)
			-12 dB - +6 dB
	BASS		0 dB (Default)
			-12 dB - +6 dB
	MIX OUT		L+R (Default)
			L
			R
	BLUETOOTH	BACK	
		BLUETOOTH	ON (Default)
			OFF
			ID (4-digit unique device number)
			CONTROL PAIR
			AUDIO PAIR
			LINK SPEAKERS
		BACK	
	LED		ON (Default)
			OFF

		LIMIT
DISPLAY	BACK	
	DIM	ON (Default)
		OFF
	BRIGHT	5 (Default)
		1 - 10
	CONTRAST	5 (Default)
1 - 10		
BACK		
STORE		BACK, 1, 2, 3, 4, 5, BACK
RECALL		BACK, 1, 2, 3, 4, 5, 6 (Default), BACK
STANDBY		15 min (Default)
		15 min - 60 min, OFF
RESET	DEFAULT SETTINGS?	NO (Default)
		YES
	ERASE USER PRESETS?	NO (Default)
		YES
INFO		[FIRMWARE VERSION]
		©2021 Electro-Voice
EXIT		

Table 5.2: Loudspeaker DSP control menu BASIC mode

EXIT menu

The **EXIT** menu is used to return to the home screen.



Notice!

The display returns to the home screen after 30 seconds of inactivity.

FUNCTION menu

The **FUNCTION** menu is used to configure between **MIXER** and **BASIC** functions:

- **BASIC** - provides input and output gain controls, 3-band EQ, and system delay for simplified audio setups or used as satellite or R-channel stereo setup.
- **MIXER** - provides full access and control of the mixer.

MODE menu

The **MODE** menu is used to configure the type of sound the loudspeaker delivers.

Available options for this selection are: **MUSIC**, **LIVE**, **SPEECH** and **CLUB**.

- **MUSIC** - is used for recorded music playback and electronic dance music applications.
- **LIVE** – is used for live sound applications.
- **SPEECH** – is used for spoken word applications.
- **CLUB** – is used for recorded electronic music playback.

The default is **MUSIC**.

LOCATION menu

The **LOCATION** menu is used to optimize the loudspeaker for different boundaries.

Available options for this selection are: **TRIPOD**, **KICKBACK**, **MONITOR**.

- **TRIPOD** - is used when the loudspeaker is placed on a tripod stand or placed on a pole.
- **KICKBACK** - is used when the loudspeaker is placed on the angled rear kickback position. This setting compensates for the amount of low frequency boost created by placing the loudspeaker on a level and stable flat surface.
- **MONITOR** - is used when the loudspeaker is placed on the angled monitor panel in monitor position. This setting compensates for the amount of low frequency boost created by placing the loudspeaker on a level and stable flat surface.

The default is **TRIPOD**.

SUB menu

The **SUB** menu is used to select a high pass frequency for use with a subwoofer.

Available options for this selection are: **OFF**, **100 Hz**, **120 Hz**, **150 Hz**, **ELX200-12SP**, **ELX200-18SP**, **EKX-15SP** and **EKX-18SP**. The **100 Hz**, **120 Hz**, and **150 Hz** choices are generic high pass settings for use with other subwoofers. The **ELX200-12SP**, **ELX200-18SP**, **EKX-15SP** and **EKX-18SP** settings are specifically optimized for subwoofers by including delay for best summation.

The default is **OFF**.

TREBLE control

The **TREBLE** control is used to adjust the high frequency performance of the loudspeaker for different applications or personal preference. The parameter controls a high shelving filter.

The default is **0 dB**.

MID control

The **MID** control is used to adjust the midrange frequency performance of the loudspeaker for different applications or personal preference.

The default is **0 dB**.

BASS control

The **BASS** control is used to adjust the low frequency performance of the loudspeaker for different applications or personal preference. The parameter controls a low shelving filter.

The default is **0 dB**.

MAIN PEQ menu

The **MAIN PEQ** is used to adjust the frequency response of the loudspeaker for different applications or personal preference. There are seven equalization filters available.

The filter type is selectable between the following:

PEQ - Parametric Equalization Filters shape the sound using peak/dip bell shaped filters which have three controls.

- **Q** - Quality Factor defines the bandwidth width of the filter. A lower **Q** provides a wider bandwidth and a higher **Q** provides a narrower bandwidth.
- **FREQ** - selects the center frequency of the EQ filter.
- **GAIN** - sets the amount of increase or reduction of the equalization filter.

LOW/HI SHELF - Shapes the sound using a shelving type filter that can be applied to the low frequency or high frequency response using two controls:

- **FREQ** - sets the center frequency of the filter. For the **LOW SHELF** filter the **GAIN** of the filter tapers off above the frequency selected. For the **HIGH SHELF** filter the **GAIN** of the filter tapers off below the frequency selected.
- **GAIN** - sets the amount of increase or reduction of the signal below or above the **FREQ** setting.

LOW/HI PASS - Pass band filters that shape the sound by only passing signal above or below the selected frequency.

- **FREQ** - sets the corner frequency for the pass band filter. For **HI PASS** filters all frequencies above the selection will be passed through. Frequencies below the setting will be tapered off. For **LOW PASS** filters all frequencies below the selection will be passed through. Frequencies above the selection will be tapered off.

MAIN GEQ menu

The **MAIN GEQ menu** is used to adjust the frequency response of the loudspeaker for different applications or personal preference. There are seven different EQ filters available centered at the following frequencies: 63, 160, 400, 1.0K, 2.5K, 6.0K & 12K Hz. The filter is also independent of the **MAIN GEQ** setting if **AUX OUT** is set to **MAIN MIX**.

The range of each filter is -12 dB to +12 dB.

The default value for each filter is **0 dB**.

FX & FX ENABLE

The **FX** control is used to select the desired effect (e.g. reverb, chorus, delay, etc.) to apply to the FX send. The FX send level is independently controlled in the INPUT 1 and INPUT 2 FX control. The **FX ENABLE** turns **ON** or **OFF** the effect globally. **FX ENABLE** can be toggled with a footswitch.

AFS (automatic feedback suppression)

The 12-band automatic feedback suppression (AFS) can be engaged to reduce unwanted feedback frequencies when microphones or instruments with pickups are used. Feedback occurs when sound from the loudspeaker enters the microphone or pickup and is amplified by the loudspeaker and played back again. High levels or extended periods of feedback can damage hearing and equipment.

Available options for this selection are **OFF** and **ON**.

Reducing feedback

To reduce feedback:

1. Set the loudspeaker and microphone or instrument according to your performance. Follow appropriate microphone placement and use practices:
 - Do not place the microphone directly in front of the loudspeaker. Refer to the user manual of your microphone to know the pickup and rejection patterns of your microphone.
 - Avoid placing music stands, tablets, or other large flat objects near the microphone such that they can cause audio reflections into the microphone.
 - Use proper microphone technique when speaking, singing or playing by an instrument to avoid using excessive input gain. For example, hold the microphone close to your mouth when performing.
 - Engage appropriate input channel **PRESET** for your application: **LOW CUT 80 Hz**, **LOW CUT 120 Hz**, **VOCAL MIC**, **VOICE FILTER**, **SPEECH**, **ACOUSTIC GUITAR**, etc. Refer to *INPUT DSP control menu, page 44*.

- Do not cup the microphone element with your hands while speaking or singing. Only hold the microphone by the handle or body as per the microphone manufacturer's recommendation.
- 2. Enable automatic feedback suppression (AFS) in the DSP control menu or FX section of the QuickSmart Mobile app. This will enable **AFS** on **INPUT 1** and **INPUT 2**.
- 3. Slowly turn up the output of the loudspeaker, and begin sound checking your microphone or instrument.
- 4. As you hear feedback, allow a few seconds for the automatic feedback suppression (AFS) to detect and to reduce the feedback.
- 5. Continue sound check until no additional feedback tones are generated.

MIX OUT menu

The **MIX OUT** menu is used to select which signal(s) should be output at **MIX OUT** and which signal should be delivered by the loudspeaker.

- **L+R** - The left and right signals of all inputs are summed. The sum is output at **MIX OUT** and is delivered by the loudspeaker (default).
- **L** - Only the panned left signal of all inputs is output at **MIX OUT**. The loudspeaker will deliver only the right signal.
- **R** - Only the panned right signal of all inputs is output at **MIX OUT**. The loudspeaker will deliver only the left signal.

BLUETOOTH menu

The **BLUETOOTH** menu is used to set the Bluetooth® functionality of the loudspeaker.

ON/OFF - The **ON/OFF** menu controls whether Bluetooth® functionality is enabled or disabled on the loudspeaker.

CONTROL PAIR - The **CONTROL PAIR** menu is used to enable the QuickSmart Mobile app wireless control and monitoring application. Available options for this selection are: ON or OFF.

The default is **OFF**.

AUDIO PAIR - The **AUDIO PAIR** menu is used to stream audio from your Bluetooth® enabled device to the loudspeaker system. Available options for this selection are: **PAIRING**, **ON** or **OFF**.

The default is **OFF**.

LINK SPEAKERS

The **LINK SPEAKERS** function allows two EVERSE loudspeakers to be linked over Bluetooth® in true wireless stereo.

To link two EVERSE loudspeakers:

1. Pair one of the EVERSE loudspeakers via Bluetooth® to a mobile device. Refer to *Pairing the QuickSmart Mobile app, page 18* for pairing instructions.
2. In both EVERSE loudspeakers, navigate to the **BLUETOOTH** menu in the Main DSP menu.
3. In both EVERSE loudspeakers, select **LINK SPEAKERS**.

The LCD display will show **LINKING SPEAKERS...** while establishing connection between both EVERSE loudspeakers. When the connection is established, the menu will display **UNLINK SPEAKERS**.

In the **BLUETOOTH** menu below the **LINKING SPEAKERS**, the stereo channel selection will appear.

4. Select the appropriate stereo channel selection for each EVERSE loudspeaker: **L+R** (mono), **L**, or **R**.

Note: This is stereo image from the audience's perspective, also known as House L & R.

LED menu

The **LED** menu shows power on and indicates limit. Available options for this selection are: **ON**, **OFF** or **LIMIT**.

- **ON** - turns the LED on when the power switch is set to ON and system is not in standby mode.
- **OFF** - turns the LED off.
- **LIMIT** - turns the LED off under normal operation. The LED brief blinking indicates the limiter is activating. Short-term blinking is not critical because the integrated limiter keeps distortion under control. Constant lighting of the LED indicates the sound is negatively affected. If the LED is constantly lit, check the rear LCD for more information. Reducing the output volume is strongly recommended.

The default is **ON**.

LCD DIM menu

The **LCD DIM** menu is used to dim the display when the display is idle for 30 seconds. Available options for this selection are: **ON** or **OFF**.

The default is **ON**.

BRIGHT menu

The **BRIGHT** menu is used to determine the brightness of the LCD. The range is 1 (darkest) to 10 (brightest).

The default is **5**.

CONTRAST menu

The **CONTRAST** menu is used to increase or decrease the visibility of the LCD screen based on lighting conditions.

The range is 1 (less contrast) to 10 (more contrast).

The default is **5**.

STORE menu

The **STORE** menu allows you to create up to five customized user settings. Available options for this selection are: **BACK**, **1**, **2**, **3**, **4**, and **5**.

**Notice!**

The customized user setting name can contain a combination of alphanumeric characters including spaces. The alphanumeric character range is A to Z and 0 - 9. The name field length is 12 characters.

Storing customized user settings

To store customized user settings:

1. From the DSP control menu, scroll to **STORE**.
2. Push the **MASTER VOL** knob to select **STORE**.
The **STORE** screen appears.
3. Push the **MASTER VOL** knob to select **1**.
The **Enter name for 1** screen appears.
4. Use the **MASTER VOL** knob to scroll through the characters.
The characters appear.
5. Push the **MASTER VOL** knob to select the required character.
6. Turn the **MASTER VOL** knob to move to the next character entry.
Continue selecting characters until the required name is entered.
7. Use the **MASTER VOL** knob to scroll to **SAVE**.
8. Push the **MASTER VOL** knob to select **SAVE**.
9. Repeat steps 3 through 8 to store additional customized user settings.

10. Select **EXIT** to return to the home screen.

RECALL menu

The **RECALL** menu allows you to retrieve up to five customized user settings. Available options for this selection are: **BACK**, **1**, **2**, **3**, **4**, and **5**. In addition, setting **6** is available to recall a default setting. This setting cannot be used to store user settings.

Recalling customized user settings

To recall customized user settings:

1. From the DSP control menu, scroll to **RECALL**.
2. Push the **MASTER VOL** knob to select **RECALL**.
The **RECALL** screen appears.
3. Push the **MASTER VOL** knob to select **1**.
The selected item is loaded.
4. After the preset is loaded, the menu will return to the home screen.

STANDBY menu

To extend battery life, the EVERSE loudspeaker will enter **STANDBY** mode after a set amount of time. The **STANDBY** menu allows you to set the idle time (time with no audio or control signal present) before the loudspeaker enters **STANDBY** mode.

To return to normal operation mode:

- ▶ Apply an audio signal, BLE control signal via the QuickSmart Mobile app.

Or

- ▶ Press any button on the loudspeaker.

RESET menu

The **RESET** menu is used to reset the loudspeaker to original factory settings. Available options for this selection are: **NO** or **YES**.

Resetting the system

To reset the system to original factory settings:

- ▶ From the DSP control menu, select **RESET**.
The **DEFAULT SETTINGS?** message appears.
- ▶ Select **YES**.
The **ERASE USER PRESETS?** message appears.
- ▶ Select **YES**.



Notice!

The **RESET** menu item is used to revert the loudspeaker to the original factory default settings.

INFO menu

The **INFO** menu is used to display the firmware version.

Refer to

- *Effects (FX) list, page 58*

6 Input & Mixer operation

6.1 INPUT DSP control menu

The loudspeaker INPUT DSP control menu selections are available for the EVERSE loudspeakers.

To control the mixer channels:

1. Press the input selection soft key to select the input channel.
The softkey will illuminate once selected.
2. Use the **MASTER VOL** knob to adjust the level.
3. Press the **MASTER VOL** knob to enter the input channel's DSP control menu.
4. Press the input selection soft key again to deselect the input channel for control.
The soft key will no longer be illuminated.

INPUT DSP control menu for MIXER mode

INPUTS 1 & 2		
LEVEL		0 dB (Default)
		MUTE, -80 dB - +42 dB
	EXIT	
	48V (INPUT 1 only)	OFF (Default)
		ON
	PRESET	FLAT (Default)
		LOW CUT 80
		LOW CUT 120
		VOCAL MIC
		VOICE FILTER
		ND76 VOCAL
		RE520
		ND86 VOCAL
		ND86 VOCAL
		SPEECH
		ACOUST GUITAR
		ND66 A-GTR
		ELECTRIC GUITAR
		BASS GUITAR
	PERCUSSION	
	LINE INPUT	
	COMP	OFF (Default)
OFF, 1 - 100		

	TREBLE	0 dB (Default)
		-12 dB - +12 dB
	MID	0 dB (Default)
		-12 dB - +12 dB
	BASS	0 dB (Default)
		-12 dB - +12 dB
	FX	0 dB (Default)
		-80 dB - +10 dB
	PAN	C (Default)
		10 L - 10 R
	DUCKER	OFF (Default)
		OFF, -1 - -40
	EXIT	

Table 6.3: INPUTS 1 & 2 DSP control menu MIXER mode

INPUT 3/4			
LEVEL		0 dB (Default)	
		MUTE, -80 dB - +42 dB	
	EXIT		
	TREBLE	0 dB (Default)	
		-12 dB - +12 dB	
	MID	0 dB (Default)	
		-12 dB - +12 dB	
	BASS	0 dB (Default)	
		-12 dB - +12 dB	
	BAL (stereo operation only)	C (Default)	
		10 L - 10 R	
	BLUETOOTH	BACK	
		BLUETOOTH	ON (Default)
			OFF
		ID (4-digit unique device number)	
		CONTROL PAIR	
AUDIO PAIR			

		LINK SPEAKERS
		BACK
	EXIT	

Table 6.4: INPUT 3/4 DSP control menu MIXER mode

INPUT DSP control menu for BASIC mode

INPUTS 1 & 2		
LEVEL		0 dB (Default)
		MUTE, -80 dB - +42 dB
	EXIT	
	48V (INPUT 1 only)	OFF (Default)
		ON
	EXIT	

Table 6.5: INPUTS 1 & 2 DSP control menu BASIC mode

INPUTS 3/4			
LEVEL		0 dB (Default)	
		MUTE, -80 dB - +42 dB	
	EXIT		
	BLUETOOTH	BACK	
		BLUETOOTH	ON (Default)
			OFF
			ID (4-digit unique device number)
			CONTROL PAIR
			AUDIO PAIR
			LINK SPEAKERS
			BACK
		EXIT	

Table 6.6: INPUTS 3/4 DSP control menu BASIC mode

Adjusting the incoming sound

Caution is advised when adjusting the incoming sound. Usually minor changes are sufficient to produce the best results in the overall sound.

To adjust the incoming sound:

- Set all EQ controls to **0 dB** or **FLAT**.
- Avoid setting the EQ controls to extreme positions.
- Use natural reproduction as a starting point.

- Rely on your musically trained ear.

INPUT LEVEL control

The **INPUT LEVEL** control adjusts the sensitivity of the incoming signals to the internal operation level of the mixer.

To achieve a good signal input level:

1. Set the volume (**VOL**) to **MUTE** using the **MASTER VOL** knob.
2. Press the input selection soft key and use the **MASTER VOL** knob to set the **INPUT LEVEL** to **MUTE**.
3. Connect the sound source (microphone, instrument, etc) to the selected input.
4. Start the sound source at the highest volume level to be expected. Sing or speak as loudly as possible directly (close up) into the microphone.
5. While playing the sound source or singing into the microphone:
 - Increase the **INPUT LEVEL** by selecting the input channel using the input selection soft key and using the **MASTER VOL** knob, so that during the loudest part, the **CLIP** does not show. Press the input selection soft key again to deselect the input channel.
 - Increase the **MASTER VOL** until you get the required output from the loudspeaker. This is the basic channel setting.

If further adjustments to the EQ setting of the channel are necessary, perform these steps again. Changes in the sound shaping section also have an influence on the overall level of the channel.

48V (INPUT 1 only)

+48V DC phantom power is available on the XLR connector of **INPUT 1** only. Phantom power can be used to power certain devices such as DI boxes and condenser microphones (non-electret). Consult the user manual of your device before using. There is no phantom power on the TRS connectors. Phantom power is switchable.



Notice!

Switch off phantom power (default) for sources which do not require phantom power such as dynamic microphones and mixer outputs.



Notice!

Never connect a mobile device to **INPUT 1** with phantom power activated.

PRESET

The input **PRESET** adjusts the EQ and compressor settings to provide a starting point for adjusting the sound for different input types.

COMP control

The **COMP** control controls the onboard compressor to adjust the input signal processing during operation. Compressors are available on **INPUT 1** and **INPUT 2**.

- ▶ Use the **COMP** control to adjust the compressor threshold and the compression ratio simultaneously.

Adjusting the **COMP control** from 0 to 100 will result in the following:

- The gain below the threshold will increase from 0 dB to +6 dB.
- The compression ratio will increase from 1:1 to 8:1.
- The compressor will reduce the dynamic range of the audio signal proportional to the compressor setting.

Once the signal exceeds a certain threshold, the signal gets compressed. Major input level changes result in minor output level changes. Narrowing the dynamic range often allows for easier recording or mixing of the audio signal. It is recommended to start with low to moderate levels of compression (25 - 40) and increase slowly if necessary.

TREBLE/MID/BASS controls

The EQ section of the input channel allows for a broad difference in the shaping of the incoming audio signal within three frequency bands:

- **TREBLE** control - provides cymbals and vocals with more treble for a more transparent sound.
- **MID** control - provides higher output and reduces acoustical feedback by lowering the level.
- **BASS** control - adds more “punch” to the sound of a kick drum or adds “body” to the vocals.

FX

The **FX** control is used to set the amount of effect you require on that channel. Using the **FX** controls lets you easily assign an effect for musical instruments or vocals.

To determine the required level of effect:

1. Set the controls to minimum.
2. Increase the level individually and gradually until the required sound is achieved.

PAN

The **PAN** control adjusts the amount of the signal coming out of the stereo L or stereo R loudspeaker in a stereo setup. The **PAN** is not engaged for mono (single loudspeaker) setups.

DUCKER

The **DUCKER** reduces the level of the signal(s) on the other inputs whenever a signal is detected at the selected MIC/LINE input (**INPUT 1** or **INPUT 2**). If no signal is detected at the selected MIC/LINE input, the level of the signal(s) on the other inputs will return to the previous set levels.

The **DUCKER** is useful to speak over background music:

- When signal is detected on the selected MIC input, the music on the other input channel will be reduced.
- When signal is no longer detected on the selected MIC input, the music will return to the previous level.

Engaging the DUCKER

To engage the ducker:

1. Select **INPUT 1** and/or **INPUT 2**.
2. Adjust the **DUCKER** level to set the detection threshold for the selected input channel. When signal is detected on the selected input, the signal on the other inputs will be reduced by 12 dB. Typical values are -10 to -20 dB.

The table below describes the **DUCKER** operation logic. The **DUCKER** setting is the detection threshold selected on **INPUT 1** and/or **INPUT 2**. The ducked channels are the input signals that are reduced by 12 dB.

	INPUT 1	INPUT 2	Reduced channels
DUCKER SETTING	-1 dB - -40 dB	OFF	INPUTS 2 & 3/4
	OFF	-1 dB - -40 dB	INPUTS 1 & 3/4
	-1 dB - -40 dB	-1 dB - -40 dB	INPUT 3/4
	OFF	OFF	NONE

7 Recommended configurations

7.1 Connecting with mobile device

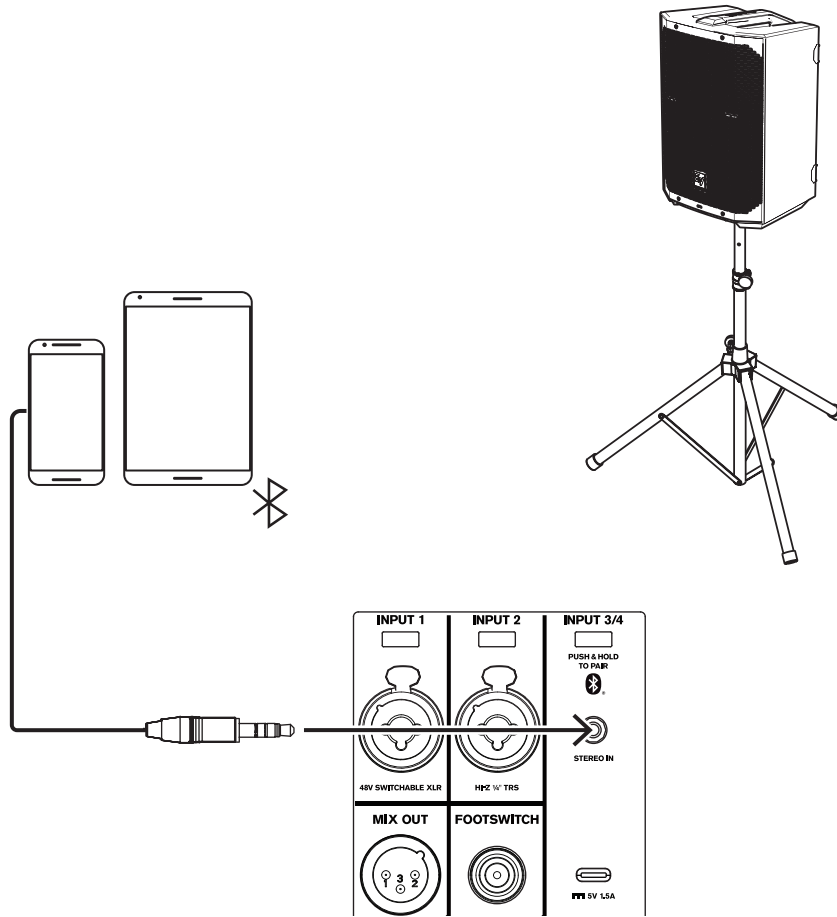

Notice!
The direction of the arrow indicates the signal path.

MODE	MUSIC
LOCATION	TRIPOD
SUB	OFF

Table 7.7: DSP settings loudspeaker on a tripod

7.2 Street musician performance

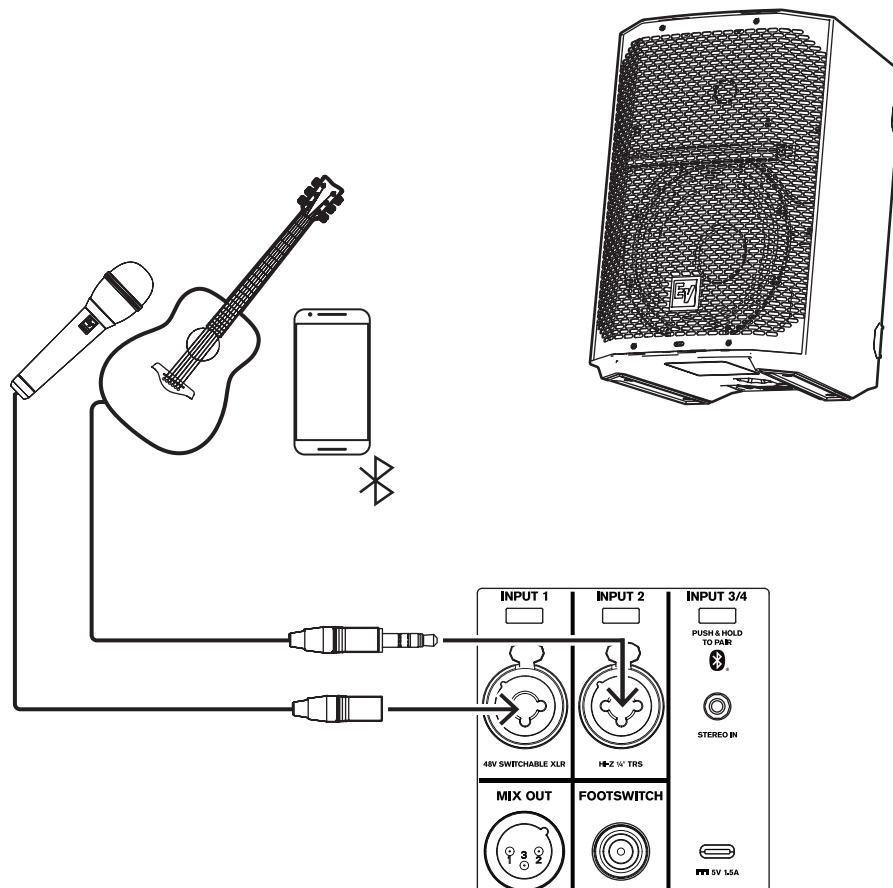

Notice!

The direction of the arrow indicates the signal path.

MODE	LIVE
LOCATION	KICKBACK
SUB	OFF
INPUT 1 PRESET	VOCAL MIC
INPUT 2 PRESET	ACOUSTIC GTR

Table 7.8: DSP settings loudspeaker in kickback position

7.3 Bluetooth true wireless stereo (TWS)

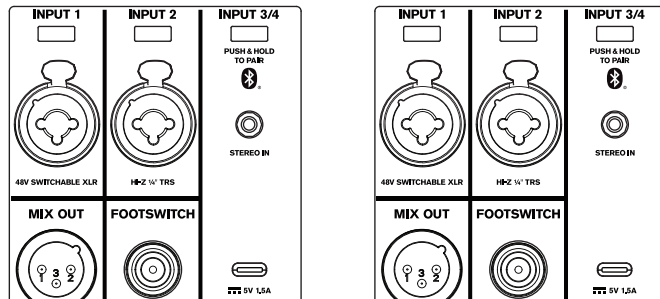
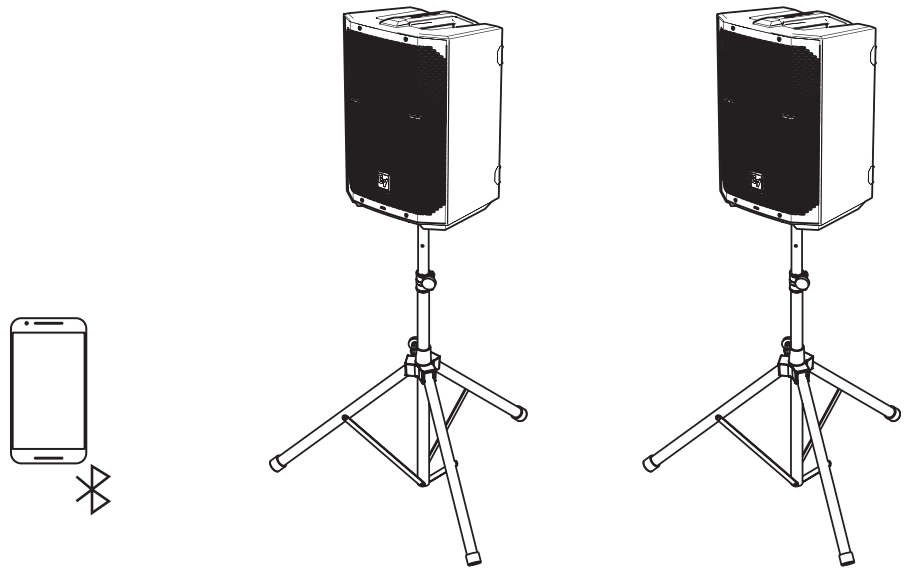

MODE	MUSIC
LOCATION	TRIPOD
SUB	OFF
INPUT PRESET	NONE

Table 7.9: DSP settings loudspeaker on a tripod

To connect two loudspeakers via TWS:

1. Connect one of the loudspeakers to your streaming device via Bluetooth®.
2. Select **LINK SPEAKERS** in the **BLUETOOTH** control menu on both loudspeakers.

7.4 Using as monitor

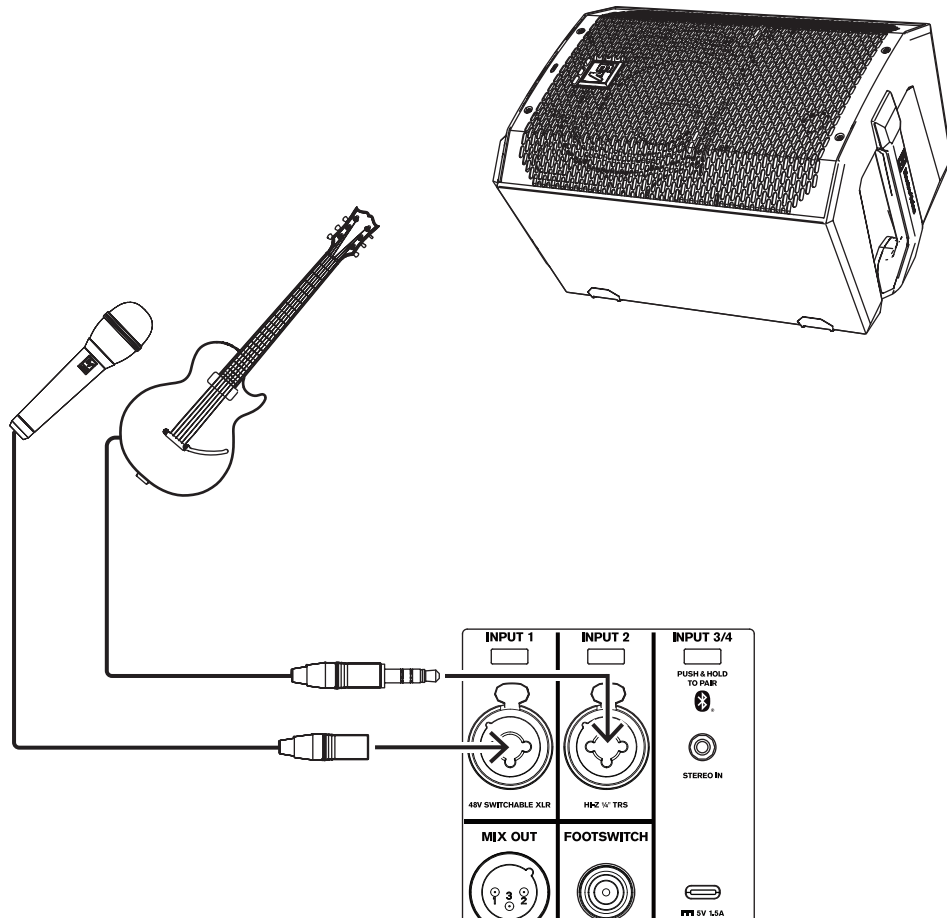

Notice!

The direction of the arrow indicates the signal path.

MODE	LIVE
LOCATION	MONITOR
SUB	OFF
INPUT 1 PRESET	VOCAL MIC
INPUT 2 PRESET	ELECTR GUIT

Table 7.10: DSP settings loudspeakers as monitors

8 Troubleshooting

Problem	Possible Cause(s)	Action
1. No sound	Improper gain	Verify all the sources are on. If the source is a condenser microphone, make sure the mic is plugged into INPUT 1 via XLR and phantom power is enabled in the menu. Inspect the VU meters on LCD or in the app. If there is signal present on the VU meters, increase the input and gain controls to the required level. If there is no signal present on the VU meters, then check the wiring.
	Sources not connected	Check all cables between the source and the loudspeaker with a multimeter or cable tester. Replace any suspect cables with a known good cable.
2. Poor Low-Frequency Response	With SUB menu cross-over frequency activated	If no subwoofers are used with the system, select the OFF position.
	SPEECH mode is active	In the DSP control menu, change the MODE to MUSIC , LIVE , or CLUB . Refer to <i>DSP controls, page 32</i> for more details.
	Input PRESET is not set to FLAT	In the INPUT DSP control menu, change PRESET to FLAT . Refer to <i>INPUT DSP control menu, page 44</i> for more details.
	EQ is active	In the INPUT and DSP control menu, reset all EQs in the low frequencies. Refer to <i>DSP controls, page 32</i> and <i>INPUT DSP control menu, page 44</i> for more details.
3. Intermittent output such as cracking or distortion	Faulty connection	Check all connections at loudspeaker to ensure they are all clean and tight. If the problem persists, check the wiring. See problem 1.
4. Constant noise such as buzzing, hissing or humming	Defective source or other electronic device	If noise is present, but no program material is playing, evaluate each component as necessary to isolate the problem. Most likely there is a break in the signal path.
	Poor system grounding or ground loop	Check and correct the system grounding, as required.
	Input gain is not at a microphone level.	Slowly increase the INPUT LEVEL to engage the microphone pre-amp.
	Mobile device is connected via USB and 3.5 mm jack simultaneously.	Some mobile devices, such as laptops and mobile phones, may introduce ground loops if the loudspeaker is charging the mobile device while simultaneously connected via the 3.5 mm audio input jack. Connect the audio via Bluetooth®, or disconnect from the USB jack.

Problem	Possible Cause(s)	Action
5. No sound produced with microphone connected to INPUT 1 or INPUT 2	Microphone requires phantom power.	Use a dynamic microphone that does not require phantom power. If using a microphone requiring phantom power, connect it to INPUT 1 via the XLR connector and enable phantom power. Refer to <i>INPUT DSP control menu, page 44</i> for more details.
	Input gain is too low	Slowly increase the input gain knob level to engage the microphone pre-amp.
6. Sound is distorted, front LED is OFF , LCD screen LIMIT is ON	Excessive INPUT LEVEL	Reduce the INPUT LEVEL or loudspeaker level knobs to prevent limit.
	Incorrect gain structure or source input (mixing console/preamp) is overdriven	Verify level controls of the source are properly structured by using the VU meter indicator on the LCD screen. If the VU meter bar is solid or the system indicates LIMIT , the input or source level is too high.
7. Microphone produces acoustic feedback when INPUT LEVEL is amplified	Automatic Feedback Suppression is OFF	Enable Automatic Feedback Suppression in the DSP Control menu. Refer to <i>DSP controls, page 32</i> for more details.
	Incorrect gain structure	Reduce the microphone levels at the mixing console or input source. If the microphone is connected directly to the loudspeaker, reduce the INPUT LEVEL on the loudspeaker. Positioning the microphone close to the sound source increases gain-before-feedback. See problem 6.
	MODE is set to MUSIC	Change the MODE to LIVE or SPEECH .
	Microphone position is too close to the front of the loudspeaker	Whenever possible setup the loudspeakers so the microphone is behind them. If using the loudspeaker in a monitor position, aim the loudspeaker to the back of the microphone.
8. DSP control menu is locked	The menu LOCK function has been turned on. A lock symbol displays on the LCD screen.	Press the MASTER VOL knob or input selection soft keys to unlock.
9. QuickSmart Mobile app does not detect the loudspeaker	Enable Bluetooth®	Ensure Bluetooth® is enabled on the loudspeaker. For Android: ensure location services are activated. Remove loudspeaker from iOS/Android in device settings (sometimes called "FORGET"). Restart pairing. Ensure phone/tablet has required OS version and latest updates installed. Ensure the latest QuickSmart Mobile App is installed. Ensure no other phone/tablet is connected to the same loudspeaker.

Problem	Possible Cause(s)	Action
10. No reaction of loudspeaker to user interaction or power cycles	Unforeseen internal operation failure	Remove mains and battery, put battery back into loudspeaker. Or Press and hold soft key for INPUT 1 and INPUT 2 for at least 10 seconds.
If these suggestions do not solve your problem, contact your nearest Electro-Voice dealer or Electro-Voice distributor.		

9 Technical data

EVERSE8-EU 8" 2-way speaker and EVERSE8-US 8" 2-way speaker

Frequency response (-3 dB) ¹ :	60 Hz to 20 kHz
Frequency range (-10 dB) ² :	50 Hz to 20 kHz
Max. SPL ³ :	121 dB
Coverage angle (H x V):	100° x 100°
Amplifier rating:	400 W
LF transducer:	8 in. woofer - ferrite magnet
HF transducer:	1 in. titanium dome, neodymium magnet, ferro-fluid cooled
Crossover frequency:	2.5 kHz
Connectors:	2 - XLR/TRS Combo 1 - 3.5mm Stereo 1 - Charge port 1 - TRS footswitch 1 - 12 V DC power output
Enclosure:	Polypropylene
Grille material:	Powder coated steel
USB charging:	1.5 A max., device-dependent
Color:	Black & white
Dimensions (H x W x D):	400 mm x 275 mm x 272 mm 15.75 in. x 10.83 in. x 10.71 in.
Net weight:	7.6 kg 16.8 lb
Shipping weight:	11 kg 24.3 lb
Power consumption ⁴ :	100 - 240 V~, 50 - 60 Hz, 0.8 - 0.6 A
Battery capacity:	86.4 Wh
Battery run time (at max. output) ⁵ :	6+ hours
Battery run time (at moderate output) ⁶ :	12+ hours
<p>¹Full space measurement using music DSP preset. ²Half-space measurement. ³Maximum SPL is measured at 1 m using broadband pink noise at maximum output. ⁴Current rating is 1/8 power. ⁵Maximum output before loudspeaker limit indication, with typical program material. ⁶Moderate output is approximately 95 dB SPL, with typical program material.</p>	

9.1 Dimensions

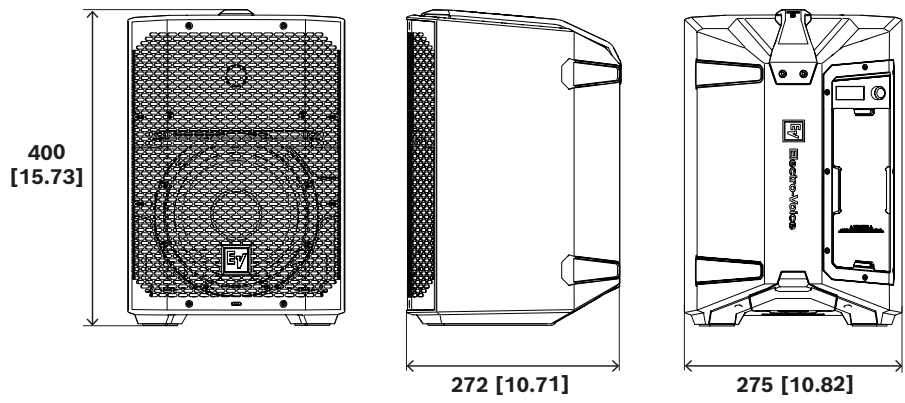

mm [in]

9.2 Frequency response

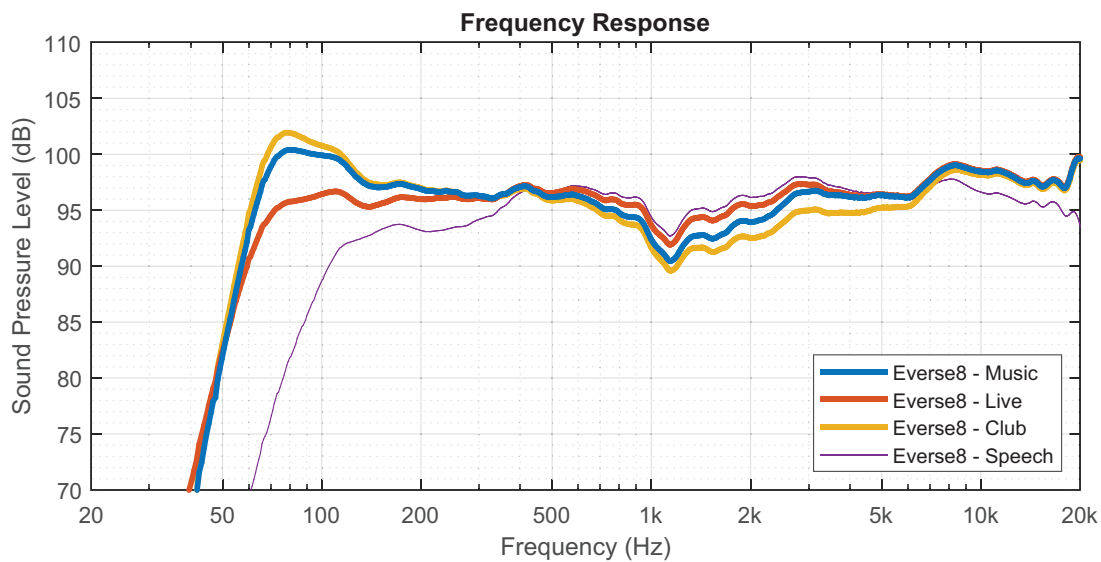

10**10.1**

Note: Subject to change without notice

Appendices

Effects (FX) list

Number	Name App	Name LCD
0	OFF	OFF
1	Echo+ReverbShort	ECHO+REVERB S
2	Reverb Room	REV ROOM
3	Reverb Concert Hall	REV CONCERT
4	Reverb Large Hall	REV HALL
5	Reverb Church	REV CHURCH
6	Reverb Room Soft	REV ROOM S
7	Reverb Concert Hall Soft	REV CONCERT S
8	Reverb Large Hall Soft	REV HALL S
9	Reverb Church Soft	REV CHURCH S
10	Reverb Cathedral Soft	REV CATHEDRAL S
11	Reverb Plate Medium	PLATE MEDIUM
12	Reverb Plate Long	PLATE LONG
13	Reverb Plate Medium Soft	PLATE MEDIUM S
14	Reverb Plate Long Soft	PLATE LONG S
15	Reverb+ChorusSlow	REV+CHORUS SLOW
16	Reverb+ChorusMedium	REV+CHORUS MEDIUM
17	Reverb+ChorusFast	REV+CHORUS FAST
18	Delay Short	DELAY SHORT
19	Delay Long	DELAY LONG
20	Delay Tap	DELAY TAP
21	Chorus Slow	CHORUS SLOW
22	Chorus Medium	CHORUS MEDIUM
23	Chorus Fast	CHORUS FAST
24	Chorus+Echo Slow	CHORUS+ECHO S
25	Chorus+EchoMedium	CHORUS+ECHO M
26	Chorus+Echo Fast	CHORUS+ECHO F
27	Slap Back+EchoSlow	SLAPBACK+ECHO S
28	Slap Back+EchoFast	SLAPBACK+ECHO F
29	Doubling Narrow	DOUBLING NARROW
30	Doubling Wide	DOUBLING WIDE

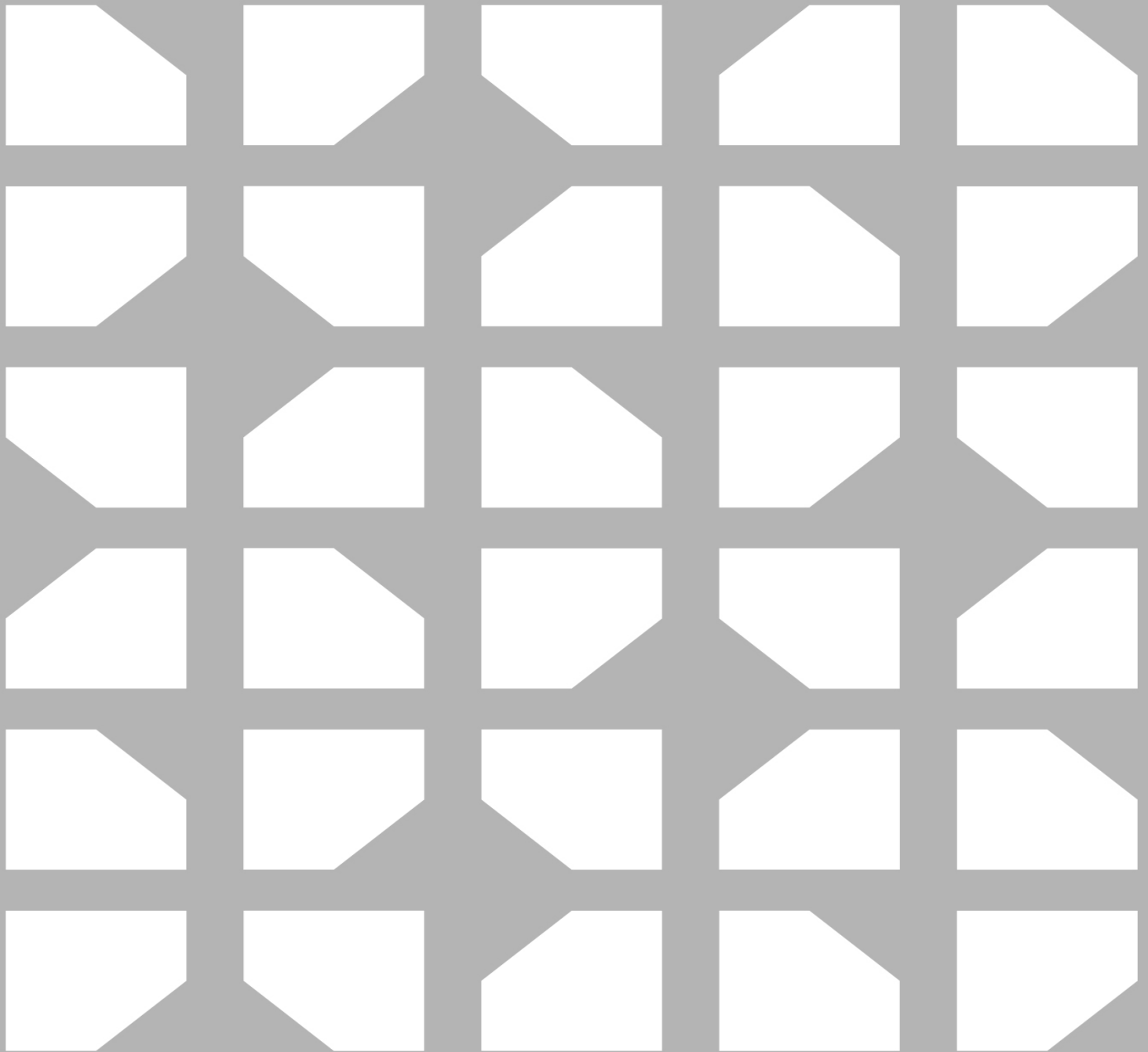

F01U401530

Bosch Sicherheitssysteme GmbH

Robert-Bosch-Ring 5
85630 Grasbrunn
Germany

www.boschsecurity.com

© Bosch Sicherheitssysteme
GmbH, 2022

Bosch Security Systems, LLC

12000 Portland Avenue South
Burnsville MN 55337
USA

www.electrovoice.com

© Bosch Security Systems,
LLC, 2022